

# DIAPHRAGM PUMP

*MV 10 NT VARIO select*  
*MD 12 NT VARIO select*  
*ME 16 NT VARIO select*



## Instructions for use



## **Original instructions Keep for further use!**

*This manual is only to be used and distributed in its complete and original form. It is strictly the user's responsibility to carefully check the validity of this manual with respect to the product.*

Manufacturer:

**VACUUBRAND GMBH + CO KG**  
**Alfred-Zippe-Str. 4**  
**97877 Wertheim**  
**GERMANY**

Phone:

Head office +49 9342 808-0  
Sales +49 9342 808-5550  
Service +49 9342 808-5660

Fax: +49 9342 808-5555

Email: [info@vacuubrand.com](mailto:info@vacuubrand.com)

Web: [www.vacuubrand.com](http://www.vacuubrand.com)

*Thank you for purchasing this product from **VACUUBRAND GMBH + CO KG**. You have chosen a modern and technically high quality product.*

# TABLE OF CONTENT

<b>1</b>	<b>Introduction</b>	<b>5</b>
1.1	User information . . . . .	5
1.2	About this document. . . . .	6
1.2.1	Manual structure . . . . .	6
1.2.2	Display conventions . . . . .	7
1.2.3	Symbols and icons . . . . .	8
1.2.4	Handling instructions (action steps). . . . .	9
1.2.5	Abbreviations . . . . .	9
1.2.6	Term definitions. . . . .	10
<b>2</b>	<b>Safety information</b>	<b>11</b>
2.1	Usage. . . . .	11
2.1.1	Intended use . . . . .	11
2.1.2	Improper use. . . . .	12
2.1.3	Foreseeable misuse. . . . .	12
2.2	Obligations . . . . .	13
2.2.1	Operator obligations . . . . .	13
2.2.2	Personnel obligations . . . . .	13
2.3	Target group description. . . . .	14
2.4	General safety information . . . . .	15
2.4.1	Protective clothing. . . . .	15
2.4.2	Safety precautions . . . . .	15
2.4.3	Laboratory and working materials. . . . .	16
2.4.4	Eliminate sources of danger . . . . .	17
2.5	Motor protection . . . . .	20
2.6	ATEX equipment category . . . . .	21
2.7	Proper disposal . . . . .	22
<b>3</b>	<b>Product description</b>	<b>23</b>
3.1	Schematic design . . . . .	23
3.2	Diaphragm pump series . . . . .	24
<b>4</b>	<b>Installation and connection</b>	<b>25</b>
4.1	Transport . . . . .	25
4.2	Installation . . . . .	26
4.3	Controller base . . . . .	28
4.4	Connection . . . . .	29
4.4.1	Assemble silencer (Option). . . . .	29
4.4.2	Vacuum connection (IN) . . . . .	30
4.4.3	Outlet connection (EX) . . . . .	32
4.4.4	Connect venting valve (optional). . . . .	34
4.4.5	Electrical connection. . . . .	35

<b>5</b>	<b>Commissioning (operation)</b>	<b>37</b>
5.1	Switch on . . . . .	37
5.2	Operation . . . . .	38
5.2.1	Operation (→ see description of controller). . . . .	39
5.3	Shutdown (switch off) . . . . .	41
5.4	Storage. . . . .	42
<b>6</b>	<b>Troubleshooting</b>	<b>43</b>
6.1	Technical support. . . . .	43
6.2	Error – Cause – Remedy . . . . .	43
<b>7</b>	<b>Cleaning and maintenance</b>	<b>47</b>
7.1	Information on service work . . . . .	48
7.2	Cleaning . . . . .	50
7.2.1	Diaphragm pump . . . . .	50
7.2.2	Clean or replace molded PTFE hoses . . . . .	50
7.2.3	Clean or replace the controller . . . . .	50
7.3	Diaphragm pump maintenance . . . . .	51
7.3.1	Maintenance items . . . . .	51
7.3.2	Preparation . . . . .	52
7.3.3	Replacing the diaphragms and valves . . . . .	55
<b>8</b>	<b>Appendix</b>	<b>71</b>
8.1	Technical information . . . . .	71
8.1.1	Technical data. . . . .	71
8.1.2	Wetted materials. . . . .	74
8.1.3	Rating plate. . . . .	75
8.2	Ordering information. . . . .	76
8.3	Service . . . . .	78
8.4	Index. . . . .	79
8.5	EC Declaration of Conformity. . . . .	81
8.6	UKCA Declaration of conformity . . . . .	82
8.7	Declaration of Conformity 符合性声明 – China RoHS 2 . . . . .	83

# 1 Introduction

This manual is part of your product. The manual applies to all variants of the pump and is intended in particular for laboratory staff.

## 1.1 User information

### Safety

---

Instructions for use  
and safety

- Read this manual thoroughly and completely before using the product.
- Keep this manual in an easily accessible location.
- Correct use of the product is essential for safe operation. Comply with all safety information provided!
- In addition to this manual, adhere to the accident prevention regulations and industrial safety regulations applicable in the country of use.

### General

---

General  
information

- For easier readability, the general term *diaphragm pump is used as an equivalent to and instead of the product name Mx 1x NT VARIO select diaphragm pump.*
- If passing the product on to a third party, also give them this manual.
- The illustrations in this manual are only intended to facilitate comprehension.
- We reserve the right to make technical changes in the course of continuous product improvement.

### Copyright

---

Copyright ©

The content of this manual is protected by copyright. Only copies for internal use are allowed, e.g., for professional training.

© VACUUBRAND GMBH + CO KG

## Contact

Contact  
US

- If your manual is incomplete, you can request a replacement. Alternatively, you can use our download portal: [www.vacuubrand.com](http://www.vacuubrand.com)
- You are welcome to contact us at any time in writing or by telephone if you would like more information, have questions about our products or wish to share feedback with us.
- When contacting our Service Department, please have the serial number and product type at hand → see *Rating plate on the product*.

## 1.2 About this document

### 1.2.1 Manual structure

Modular instructions  
for use

The manual has a modular structure with separate instruction modules for the diaphragm pump, vacuum controller, and any accessories.

## Instruction modules

Pump series and  
instructions for use

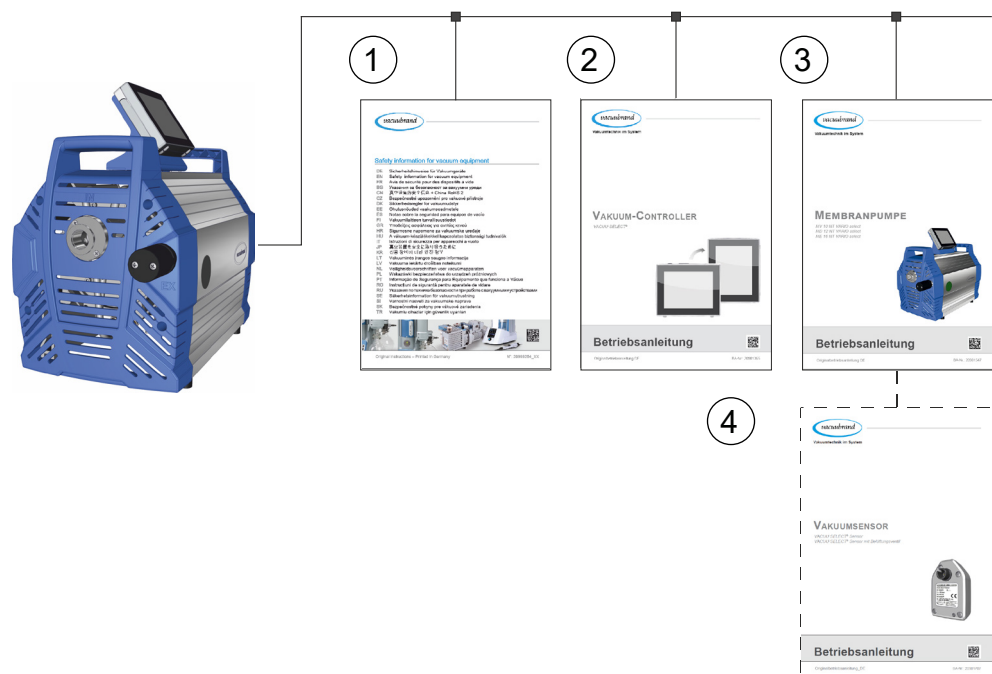



- 1 Safety information for vacuum equipment
- 2 Description: Vacuum controller – control and operation
- 3 Description: Vacuum pump – connection, operation, maintenance, mechanics
- 4 Optional description: Accessories

## 1.2.2 Display conventions

### Warning levels

Display conventions

	<b>DANGER</b>
	<p><b>Indicates an imminent hazardous situation.</b> Disregarding the situation will result in serious and even fatal injury or death.</p> <p>⇒ Take appropriate action to avoid dangerous situations!</p>

	<b>WARNING</b>
	<p><b>Indicates a potentially hazardous situation.</b> Disregarding the situation could result in serious, even fatal injury or massive damage to property.</p> <p>⇒ Take appropriate action to avoid dangerous situations!</p>

	<b>CAUTION</b>
	<p><b>Indicates a potentially hazardous situation.</b> Disregarding the situation could result in slight or minor injury or damage to property.</p> <p>⇒ Take appropriate action to avoid dangerous situations!</p>

<b>NOTICE</b>	
<p><b>Indicates a potentially harmful situation.</b> Disregarding the notice could lead to material damage.</p>	

### Additional notes

#### **IMPORTANT!**

- ⇒ Information or specific recommendation which must be observed.
- ⇒ Important information for proper operation.



- ⇒ Helpful tips + tricks
- ⇒ Additional notes

### 1.2.3 Symbols and icons

This manual uses symbols and icons. Safety symbols indicate specific risks associated with handling the product. Symbols and icons are designed to help you identify risks more easily.

#### Safety symbols

Explanation of safety symbols



Hazardous substance - hazards to human health.



General prohibition sign.



General warning sign.



Danger: hot surface



Danger: electricity.



General mandatory sign.



Disconnect power plug.



Wear chemical resistant protective gloves.



Wear protective goggles.

#### Additional icons

Additional symbols



Positive example – **Do this!**  
Result – **OK**



Negative example – **Do not do this!**



Refers to content in this manual.



Refers to content of other supplementary documents.

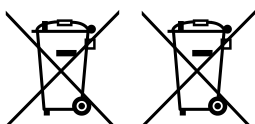

Electric/electronic devices must not be disposed of in the domestic waste at the end of their service life.



Installation at temperatures < 40 °C.



Ensure sufficient air circulation.



Flow arrow  
Inlet – vacuum connection



Flow arrow  
Outlet – exhaust gas



## 1.2.4 Handling instructions (action steps)

Display of operating steps

### Instructions (single step)

⇒ Perform the step described.

Result of action

### Instructions (multiple steps)

1. First step

2. Next step

Result of action

Perform the steps in the order described.

## 1.2.5 Abbreviations

Abbreviations

<b>abs.</b>	absolute
<b>ATM</b>	Atmospheric pressure (pressure graphic, program)
<b>d<sub>i</sub></b> (di)	Interior diameter
<b>DN</b>	Nominal diameter
<b>ECTFE</b>	Ethylene chlorotrifluoroethylene
<b>ETFE</b>	Ethylene/Tetrafluoroethylene
<b>EX*</b>	Outlet (exhaust, exit), exhaust gas connection
	ATEX equipment labeling
<b>Fig.</b>	Figure
<b>FPM</b>	Fluoroelastomer
<b>IN*</b>	Inlet, vacuum connection
<b>KF</b>	Small flange
<b>max.</b>	Maximum value
<b>min.</b>	Minimum value
<b>PP</b>	Polypropylene
<b>PPS</b>	Polyphenylene sulphide
<b>PTFE</b>	Polytetrafluorethylene
<b>resp.</b>	responsible (supervising)
<b>RMA-N°</b>	Return Merchandise Authorization number
<b>SW</b>	Wrench size (tool)

\* Labeling on vacuum pump or component

## 1.2.6 Term definitions

Product-specific terms

<b>Fine vacuum.</b>	Pressure range in vacuum technology, from: 1 mbar–0,001 mbar
<b>Rough vacuum</b>	Pressure range in vacuum technology, from: Atmospheric pressure–1 mbar
<b>Mx 1x NT VARIO select</b>	Vacuum pump with variable speed motor for precise vacuum control including <b>VACUU·SELECT®</b> controller and <b>VACUU·SELECT® Sensor</b> .
<b>VACUU·BUS®</b>	Bus system from <b>VACUUBRAND</b> for communication between peripheral devices with <b>VACUU·BUS®</b> enabled gauges and controllers. The maximum permissible cable length is 30 m.
<b>VACUU·BUS® address</b>	Address which enables the <b>VACUU·BUS®</b> client to be unambiguously assigned within the bus system, e.g., for connecting multiple sensors with the same measurement range.
<b>VACUU·BUS® client</b>	Peripheral device or component with <b>VACUU·BUS®</b> port which is integrated in the bus system, e.g., sensors, valves, level indicators, etc.
<b>VACUU·BUS® connector</b>	4-pin round connector for the bus system from <b>VACUUBRAND</b> .
<b>VACUU·BUS® configuration</b>	Assigning a different <b>VACUU·BUS®</b> address to a <b>VACUU·BUS®</b> component using a gauge or controller.
<b>VACUU·LAN®</b>	Local area vacuum network.
<b>VACUU·SELECT®</b>	Vacuum controller, controller with touchscreen; consisting of operating panel and vacuum sensor.
<b>VACUU·SELECT® Sensor</b>	External vacuum sensor ▶ for <b>VACUU·SELECT®</b> <i>or</i> ▶ separately as an independent vacuum sensor.
<b>VARIO® drive</b>	Speed control for vacuum pump; the motor runs only as fast as necessary to meet demand.

## 2 Safety information

The information in this chapter must be observed by everyone who works with the product described here.

The safety instructions are valid for the complete life cycle of the product.

### 2.1 Usage

Only use the product if it is in perfect working condition.

#### 2.1.1 Intended use

Intended use

A diaphragm pump of the *Mx 1x NT VARIO select* product series is a vacuum system consisting of a vacuum pump, controller and sensor to create and control rough vacuum in designated systems, e.g., as backing pump for high vacuum pumps, for vacuum drying or in systems with VACUU-LAN local area vacuum network etc.

The vacuum system may only be used indoors in a non-explosive atmosphere, and in a dry environment.

#### Intended use also includes:



- observing the information in the document **Safety information for vacuum equipment**,
- observing the manual,
- observing the manual of connected components,
- observing the inspection and maintenance intervals and having maintenance performed by appropriately qualified personnel.
- using only approved accessories or spare parts.

Any other use is considered improper use.

### 2.1.2 Improper use

Improper use Incorrect use or any application which does not correspond to the technical data may result in injury or damage to property.

#### Improper use includes:

- using the product contrary to its intended use,
- using the product in non-commercial environments, unless the necessary protective measures and precautions have been taken by the company,
- operation under inadmissible environmental and operating conditions,
- operation despite obvious faults or defective safety devices,
- unauthorized extensions or conversions, in particular when these impair safety,
- usage despite incomplete assembly,
- operation with sharp-edged objects,
- pulling plug-in connections on the cable out of the socket,
- aspirating, conveying, or compressing solids or fluids.

### 2.1.3 Foreseeable misuse

Foreseeable misuse In addition to improper use, there are types of use which are prohibited when handling the product:

#### Prohibited types of use are, in particular:



- use on humans or animals,
- installation and operation in potentially explosive atmospheres,
- use in mines or underground,
- using the product to generate pressure,
- fully exposing vacuum equipment to the vacuum,
- immersing vacuum equipment in liquids, or exposing it to water spray or steam jets,

- Foreseeable misuse
- pumping oxidizing and pyrophoric substances, liquids or solids,
  - pumping hot, unstable, or explosive media,
  - pumping substances which may react explosively under impact and/or elevated temperature without an air supply.

**IMPORTANT!**

**No foreign bodies, hot gases or flames from the application must be allowed to enter the equipment.**

## 2.2 Obligations

### 2.2.1 Operator obligations

Operator obligations

The owner defines the responsibilities and ensures that only trained personnel or specialists work at the vacuum system. This applies in particular to connection, assembly and maintenance work, and troubleshooting.

Users in the areas of competence in the *Responsibility matrix* must possess the relevant qualifications for the activities listed. In particular work on electrical equipment must be performed only by qualified electricians.

### 2.2.2 Personnel obligations

Personnel obligations

In the case of activities which require protective clothing, personal protective equipment as specified by the operator is to be worn. If the vacuum system is not in proper working order, it must be prevented from being accidentally switched back on.

- ⇒ Always be conscious of safety and work in a safe manner.
- ⇒ Observe instructions issued by the operator, and national regulations on accident prevention and industrial safety.



The way individuals act can help to prevent accidents at work.

## 2.3 Target group description

Target groups The manual must be read and observed by every person who is tasked with the activities described below.

### Personnel qualification

Qualification description

<b>Operator</b>	Laboratory staff, such as chemists, laboratory technicians
<b>Specialist</b>	Person with professional qualification in mechanics, electrical equipment or laboratory devices
<b>Responsible specialist</b>	Similar to a specialist, with additional specialist responsibility, or responsibility for a department or division

### Responsibility matrix

Responsibility Assignment Matrix

<b>Task (Job)</b>	<b>Operator</b>	<b>Specialist</b>	<b>Responsible specialist</b>
Installation	<b>x</b>	<b>x</b>	<b>x</b>
Initial use	<b>x</b>	<b>x</b>	<b>x</b>
Network integration			<b>x</b>
Operation	<b>x</b>	<b>x</b>	<b>x</b>
Error report	<b>x</b>	<b>x</b>	<b>x</b>
Remedy	( <b>x</b> )	<b>x</b>	<b>x</b>
Maintenance		<b>x</b>	<b>x</b>
Repair <sup>1</sup>		<b>x</b>	<b>x</b>
Repair order			<b>x</b>
Cleaning, simple	<b>x</b>	<b>x</b>	<b>x</b>
Shutdown	<b>x</b>	<b>x</b>	<b>x</b>
Decontamination <sup>2</sup>		<b>x</b>	<b>x</b>

1 see also website:

VACUUBRAND > Support > [Instructions for repair](#)

2 Alternatively, arrange for decontamination by a qualified service provider

## 2.4 General safety information

Quality standards  
and  
safety

Products from **VACUUBRAND GMBH + CO KG** are subject to stringent quality testing with regard to safety and operation. Each product undergoes a comprehensive test program prior to delivery.

### 2.4.1 Protective clothing

Protective clothing

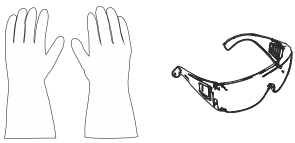

No special protective clothing is required to operate the vacuum pump. Observe instructions issued by the operator for your workplace.

During cleaning, maintenance and repair work, we recommend wearing chemical-resistant protective gloves, protective clothing and protective goggles.

#### **IMPORTANT!**

⇒ When handling chemicals, wear your personal protective equipment.

### 2.4.2 Safety precautions

Safety precautions

- ⇒ Use the vacuum device only if you have understood its function and this manual.
- ⇒ Replace defective parts immediately, e.g., a broken cable, faulty hoses, etc.
- ⇒ Use only original accessories and components which are designed for the vacuum technology, such as a vacuum hose, separator, vacuum valve, etc.
- ⇒ When handling contaminated parts, follow the relevant regulations and safety precautions, this also applies to equipment sent in for repair.

#### **IMPORTANT!**

**Prior to returning any product to our Service Department for repair, contamination from hazardous substances needs to be excluded.**

⇒ Fill out the [Health and Safety Clearance form](#) in full and confirm with your signature.

### 2.4.3 Laboratory and working materials

	<b>DANGER</b>
	<p><b>Hazardous substances could be discharged at the outlet.</b></p> <p>During aspiration, hazardous, toxic substances at the outlet can get into the ambient air.</p> <ul style="list-style-type: none"><li>⇒ Observe the national regulations for safe handling of hazardous substances.</li><li>⇒ Please note that residual process media may pose a danger to people and the environment.</li><li>⇒ Mount and use suitable separators, filters or fume hood devices.</li></ul>

#### Hazards due to different substances

Pumping different substances

Pumping different substances or media can cause the substances to react with one another.

Working materials which get into the vacuum pump with the gas flow can damage the vacuum pump. Hazardous substances can deposit in the vacuum pump.

#### **Possible protective measures, depending on the application:**

- ⇒ Flush the vacuum pump with inert gas or air before changing the medium to be pumped.
- ⇒ Use inert gas to dilute critical mixtures.
- ⇒ Prevent the release of hazardous, toxic, explosive, corrosive fluids, gases or vapors or those that are harmful to health or the environment, for example, through suitable laboratory facilities with a fume hood and ventilation control.
- ⇒ Protect the inside of the vacuum pump from deposits or moisture.
- ⇒ Be aware of interactions and possible chemical reactions of the pumped media.
- ⇒ Check the compatibility of the pumped substances with the wetted materials of the vacuum pump.
- ⇒ Contact us if you have concerns about using your vacuum pump with certain working materials or media.



## 2.4.4 Eliminate sources of danger

### Take mechanical stability into account

Note  
mechanical load  
capacity

The high compression ratio of the pump may result in a higher pressure at the outlet than the mechanical stability of the system allows.

- ⇒ Always ensure that the outlet line is clear and non-pressurized. The outlet must not be blocked to ensure that gases can exit freely.
- ⇒ Prevent uncontrolled overpressure, e.g., due to a locked or blocked piping system, condensate or clogged outlet line or silencer.
- ⇒ High gas flow can lead to overpressure at the silencer. In case of permanently high gas flow replace the silencer at the outlet by a small flange connection or a hose nozzle and connect an outlet line.
- ⇒ At the gas connections, the connections for the inlet **IN** and outlet **EX** must not be mixed up.
- ⇒ Be aware of the max. pressures at the inlet and outlet of the pump as well as the max. admissible differential pressure between the inlet and outlet, according to. **8.1.1 Technical data on page 71**
- ⇒ The system to be evacuated as well as all hose connections must be mechanically stable.

### Prevent condensate return

Prevent backup in  
the outlet line

Condensate can damage the pump head. Condensate must not flow back into the outlet **EX** or pump head through the hose line. No liquid should accumulate inside the exhaust hose or inside the silencer.

- ⇒ Avoid condensate return by using a separator (accessory). Condensate must not enter the inside of the housing via the hose lines.
- ⇒ Preferably route the exhaust gas hose with a fall from the outlet, i.e., running downward so that no backup forms.

### Prevent foreign bodies inside the pump

Observe vacuum pump dimensioning

Particles, liquids and dust must not get inside the vacuum pump.

- ⇒ Do not pump any substances which could form deposits inside the vacuum pump.
- ⇒ Install suitable separators and/or filters upstream of the inlet. Suitable filters are chemically resistant, clog-proof and have a reliable flow rate, for example.
- ⇒ Replace porous vacuum hoses without delay.

### Hazards during venting

Hazards when venting

Depending on the application, explosive mixtures can form or other hazardous situations can arise in systems.

### Hazards due to residual energy

Possible residual energies

After the vacuum pump has been switched off and disconnected from the power supply, there may still be dangers due to residual energy:

- Thermal energy: Motor waste heat, hot surface, compression heat.
  - ⇒ Allow the vacuum pump to cool down.
- Electrical energy: The capacitors on the electronic assembly have a discharge time of up to 3 minutes.
  - ⇒ Wait until the capacitors have discharged.

### Risk of burns due to hot surfaces or overheating

#### Surface temperatures

Depending on operation conditions and ambient conditions dangers due to hot surfaces may arise. Prevent any danger arising from hot surfaces. The surface temperature of the silencer in particular might be elevated in case of high gas flow.

- ⇒ Avoid direct contact with the surface.
- ⇒ Use protection against accidental contact if the surface temperature is regularly elevated.
- ⇒ Allow the vacuum pump to cool down before performing maintenance work.
- ⇒ Keep the electrical power cable away from hot surfaces.
- ⇒ Keep the electrical power cable away from heated surfaces.

#### Overheating

The vacuum pump can be damaged due to overheating. Possible causes include insufficient air supply to the fan and failure to maintain minimum distances.

- ⇒ When installing the device, ensure that there is a minimum distance of 5 cm between the fan and adjacent parts (such as the housing, walls, etc.).
- ⇒ Always ensure a sufficient air supply; if applicable, provide external forced ventilation.
- ⇒ Place the device on a stable surface; a soft surface such as foam rubber as a sound absorber can impair and block the air supply.
- ⇒ Clean polluted ventilation slots.
- ⇒ Remove covers from the device before operating it.
- ⇒ Avoid excessive heat input due to hot process gases.
- ⇒ Observe the maximum admissible media temperature  
→ *see chapter: 8.1.1 Technical data on page 71.*

### Keep signs legible

Signs and labels Keep labels and information symbols and warning labels always in a well readable condition:

- ⇒ Connection labels
- ⇒ Warning signs and notice labels
- ⇒ Motor data and rating plates

## 2.5 Motor protection

Overheating protection As **overload protection**, a temperature sensor is incorporated into the motor. In case of excess temperature, the pump is switched off.

Procedure for switching vacuum pump back on **Note:** Only manual reset is possible. If the vacuum pump is switched off due to this safety precaution, the error must be cleared manually: Acknowledge the error message at the controller → Switch off pump or unplug pump from power supply → Determine and eliminate cause of error → Allow pump to cool down and switch vacuum pump back on.

## 2.6 ATEX equipment category

### Installation and potentially explosive atmospheres



**Installation and operation in areas where potentially explosive atmospheres can develop to a hazardous degree is not permitted.**

**ATEX approval only applies to the internal, wetted parts of the of the product, not to its surroundings.**

### ATEX equipment labeling

ATEX  
equipment category

Vacuum equipment labeled with  has ATEX approval in line with the ATEX marking on the rating plate.



- ⇒ Only use the product if it is in perfect working condition.
- ⇒ The devices are designed for a low level of mechanical stress and must be installed in such a way that they cannot sustain mechanical damage from the outside.

ATEX  
equipment category  
and  
peripherals

The ATEX equipment category of the product is dependent on the connected components and peripheral devices. Components and connected peripherals need to have the same or higher ATEX approval.

Prevent  
ignition sources

The use of venting valves is only permitted if this would not normally, or only rarely, cause explosive mixtures within the device, or do so only for a short time.

- ⇒ If necessary vent with inert gas.

Information on the ATEX equipment category is also available on our website at: [www.vacuubrand.com/.../Information-ATEX](http://www.vacuubrand.com/.../Information-ATEX)

## Restrictions on operating conditions

Meaning for devices marked with X:

Explanation of usage conditions X  
Example extract type plate

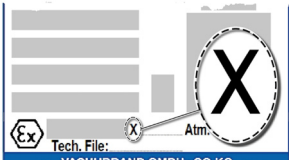

- The devices have a low mechanical protection and must be installed so that they cannot be mechanically damaged from the outside; e.g., installing pump stations with impact protection, attaching shatter protection for glass flasks, etc.
- The devices are designed for an ambient and media temperature of +10 °C to +40 °C during operation. These ambient and media temperatures must never be exceeded. When conveying/measuring non-explosive gases, extended gas suction temperatures apply, see chapter: Technical information, media temperature (gas).

## 2.7 Proper disposal

### NOTE

**Electronic components and batteries must not be disposed of in the domestic waste at the end of their service life.**

Used electronic devices and batteries contain harmful substances that can cause damage to the environment or human health. Disused electrical devices also contain valuable raw materials, which can be recovered for reuse if the device is disposed of correctly within the recycling process.

End users are legally obliged to take used electric and electronic devices to a licensed collection point and to return spent batteries.

- ⇒ It is your responsibility to save and delete any data before disposing of your electronic device.
- ⇒ If the device contains batteries: Remove spent batteries before disposal.
- ⇒ Correctly dispose of all electronic scrap and electric components at the end of their service life.
- ⇒ Observe the national regulations regarding disposal and environmental protection.



### 3 Product description

The diaphragm pumps described essentially consist of a diaphragm pump with VARIO® drive, a **VACUU-SELECT®** vacuum controller and a **VACUU-SELECT® Sensor**. The pump is equipped with a frequency converter and a switching power supply.

#### 3.1 Schematic design

Side and front view

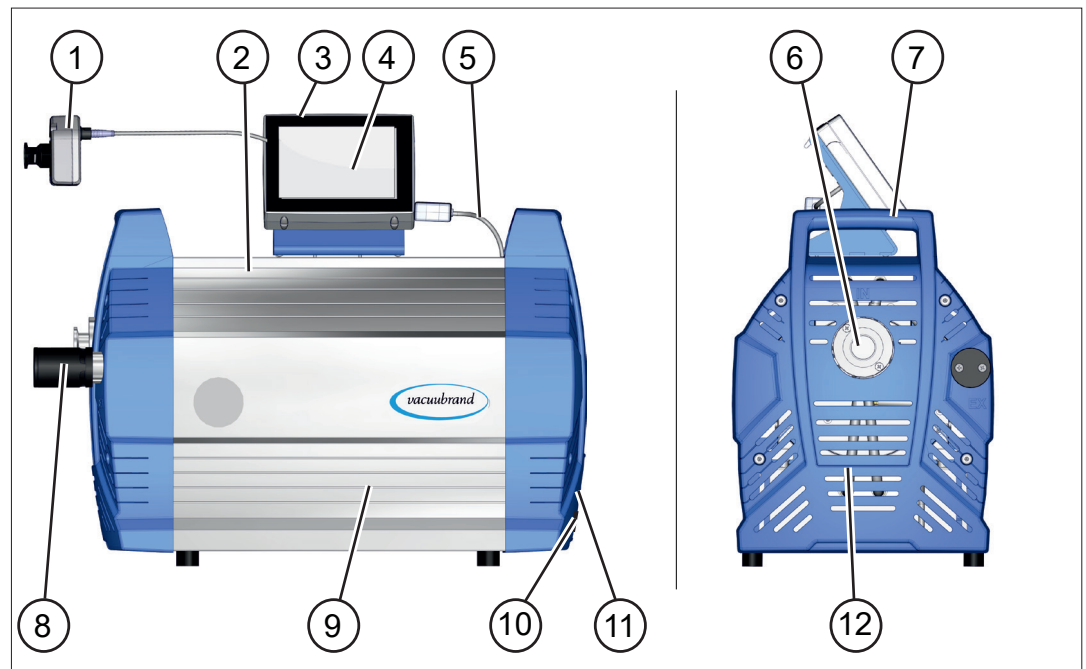

Meaning

1	<b>VACUU-SELECT® Sensor</b> , to be mounted externally on suction line
2	Diaphragm pump
3	Vacuum controller ON/OFF button
4	<b>VACUU-SELECT®</b> operating panel
5	<b>VACUU-SELECT®</b> VACUU-BUS cable (power supply + control cable)
6	Vacuum connection – inlet IN
7	Handles (2x)
8	Outlet connection – outlet EX – silencer (option)
9	Side panel, cover
10	Power connection, ON/OFF button (rocker switch)
11	Rating plate
12	Housing section with handle, front

## 3.2 Diaphragm pump series

The diaphragm pumps do not differ in their outward appearance.  
→ see figure: *3.1 Schematic design on page 23*

The diaphragm pumps differ in the internal connection of the pump heads.

### Diaphragm pumps Mx 1x NT VARIO select

Stages of  
diaphragm pump

Diaphragm pump	Pump heads	Stages
ME 16 NT VARIO select	8	1
MD 12 NT VARIO select	8	3
MV 10 NT VARIO select	8	4



## 4 Installation and connection

### 4.1 Transport

Products from **VACUUBRAND** are packed in sturdy, recyclable packaging.



The original packaging is accurately matched to your product for safe transport.

⇒ If possible, please keep the original packaging, e. g., for returning the product for repair.

### Goods arrival

Check the shipment for transport damage and completeness.

⇒ Immediately report any transport damage in writing to the supplier.

### Unpacking

→ Example  
Diaphragm pump in  
original packaging  
with enclosed  
packages

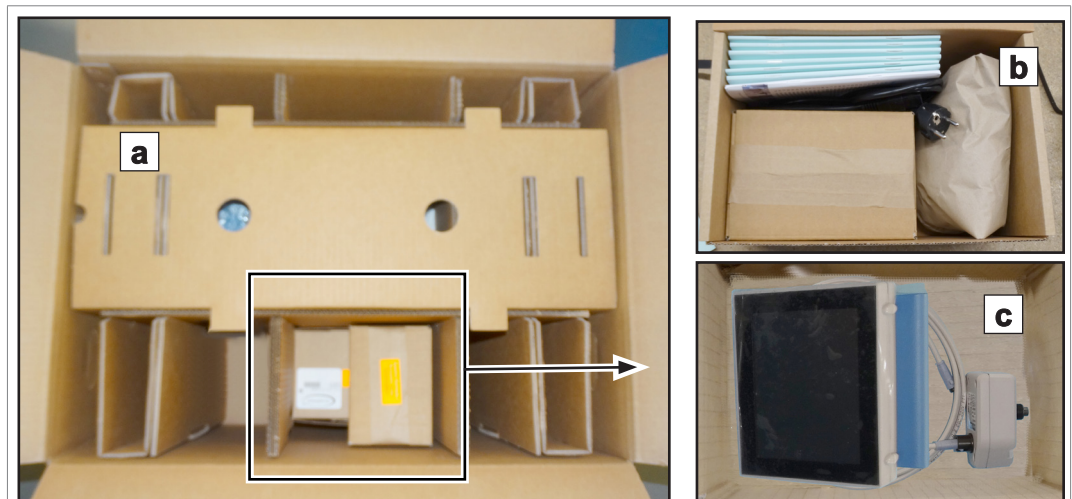

- (a) = diaphragm pump  
 (b) = manual, cable, silencer, and any accessories  
 (c) = controller, vacuum sensor, cable

⇒ Remove all enclosed packages from their original packaging and unpack them.

⇒ Compare the scope of delivery with the delivery note.

→ Example  
Lift out the  
diaphragm pump



- ⇒ Please note that a **diaphragm pump can weigh approx. 31 kg**. We recommend using a lifting aid.
- ⇒ Lift the device out of the packaging by the side handles.

## 4.2 Installation

### **NOTICE**

#### **Condensate can damage the electronics.**

A large temperature difference between the storage location and the installation location can cause condensation.

- ⇒ After goods receipt or storage, allow your vacuum device to acclimatize for at least 3-4 hours before initial use.

### **Check installation conditions**

Check installation  
conditions

- The device is acclimatized.
- Ambient conditions have been observed and are within the limitation of use.
- The pump must have a stable and secure base without additional mechanical contact apart from the pump feet.

### Installing the vacuum pump

⇒ Place the vacuum pump on a stable, non-vibrating, level surface.

→ Example Sketch of minimum distances in laboratory furniture

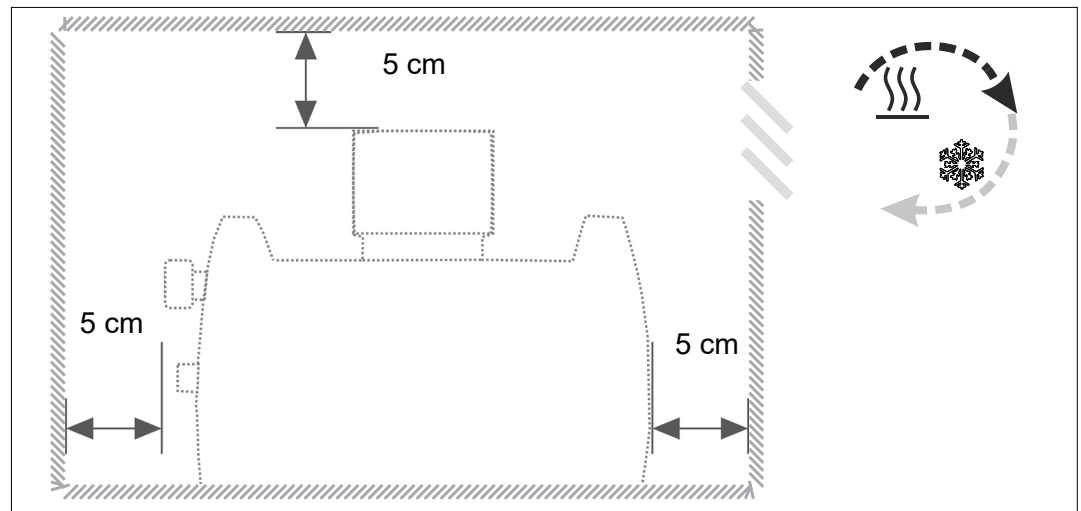

**IMPORTANT!**

⇒ When installing in lab furniture, maintain a minimum distance of 5 cm (2 in.) to adjacent objects or surfaces.

⇒ Prevent heat accumulation and ensure sufficient air circulation, especially in closed housings.

### Observe limitations of use

Observe limitation of use

Limitation of use		(US)
Ambient temperature	10 – 40 °C	50 – 104 °F
Max. altitude	2000 m above NHN	6562 ft above sea level
Minimum distance to adjacent parts	5 cm	2 in
Relative humidity	30 – 85 %, non condensing	
Protection class	IP 40/IK 08	
Prevent condensation or contamination from dust, liquids, or corrosive gases.		

**IMPORTANT!**

⇒ Note the IP protection class. IP protection is only guaranteed if the device is appropriately mounted and connected.

⇒ For connection also note the rating plate data and chapter **8.1.1 Technical data on page 71.**

### 4.3 Controller base

The base, controller, screw fittings and vacuum sensor are enclosed separately. Before installation, the base can be mounted on the pump and the controller clipped into place.

Alternatively, the controller can be clipped into a recess in the lab furniture or used as a freestanding unit (unfold the stand).

#### Mount the base

Mount the base to the diaphragm pump (option)

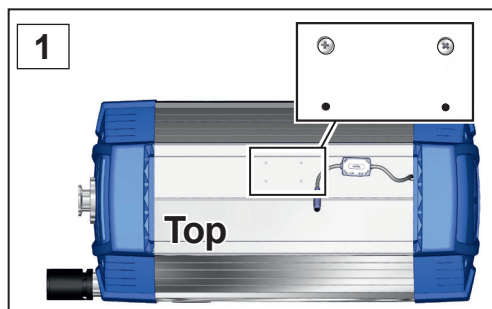

1. Unscrew the screws; Phillips screwdriver size 1.



2. Position the base on the diaphragm pump.

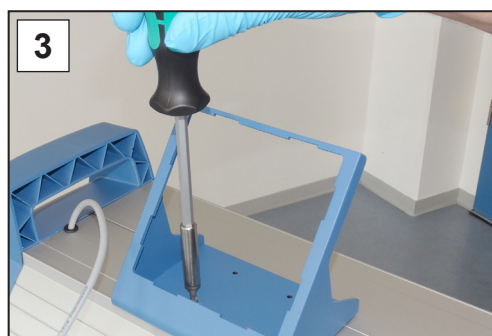

3. Screw the base onto the diaphragm pump.



4. Clip the controller into the base.



5. Plug the VACUU·BUS cable into the power connection on the back of the controller.



6. Also plug in the VACUU·BUS cables from peripheral devices. Use Y adapters (accessories) if there are not enough connections.

## 4.4 Connection

The diaphragm pumps have a vacuum connection and an outlet connection. Connect your diaphragm pump as described in the examples below.

### 4.4.1 Assemble silencer (Option)

Silencer at the outlet EX

	<b>WARNING</b>
	<p><b>Risk of bursting due to internal overpressure at the silencer.</b></p> <p>Inadmissibly high pressure at the silencer can cause the vacuum pump to burst or damage the pump bearings, diaphragms and valves.</p> <p>Internal overpressure may build up in case of high gas flow rate or in case of deposits inside the silencer caused by pumping gases containing dust or solvent vapors.</p> <ul style="list-style-type: none"><li>⇒ Do not pump any substances which could form deposits inside the silencer.</li><li>⇒ In case of permanently high gas flow or if there is a risk of deposits replace the silencer at the outlet by a small flange connection or a hose nozzle and connect an outlet line, see <b>4.4.3 Outlet connection (EX)</b> on page 32.</li></ul>

The silencer is separately packed.

## Assemble the silencer

Assemble silencer



⇒ Unpack the silencer and screw it in the thread at the outlet of the pump.

Silencer assembled.

### 4.4.2 Vacuum connection (IN)



#### CAUTION

**Flexible vacuum hoses can contract during evacuation.**

Connected components that are not secured can cause injury or damage due to jerky movement (shrinkage) of the flexible vacuum hose. The vacuum hose can come loose.

- ⇒ Fix the vacuum hose to the connections.
- ⇒ Secure connected components.
- ⇒ Take the maximum shrinkage into account when sizing the flexible vacuum hose.

#### NOTICE

**Foreign bodies in the suction line can damage the vacuum pump.**

- ⇒ Prevent particles, liquids or contaminants from being aspirated or being able to flow back.

**IMPORTANT!**

- ⇒ Use a sufficiently stable vacuum hose that is designed for the required vacuum range.
- ⇒ Keep hose lines as short as possible.
- ⇒ Connect hose lines in a gas-tight manner to the vacuum pump.
- ⇒ Avoid kinks in the vacuum hose.

**Connect the vacuum hose**

→ Example  
Vacuum connection  
at the inlet IN

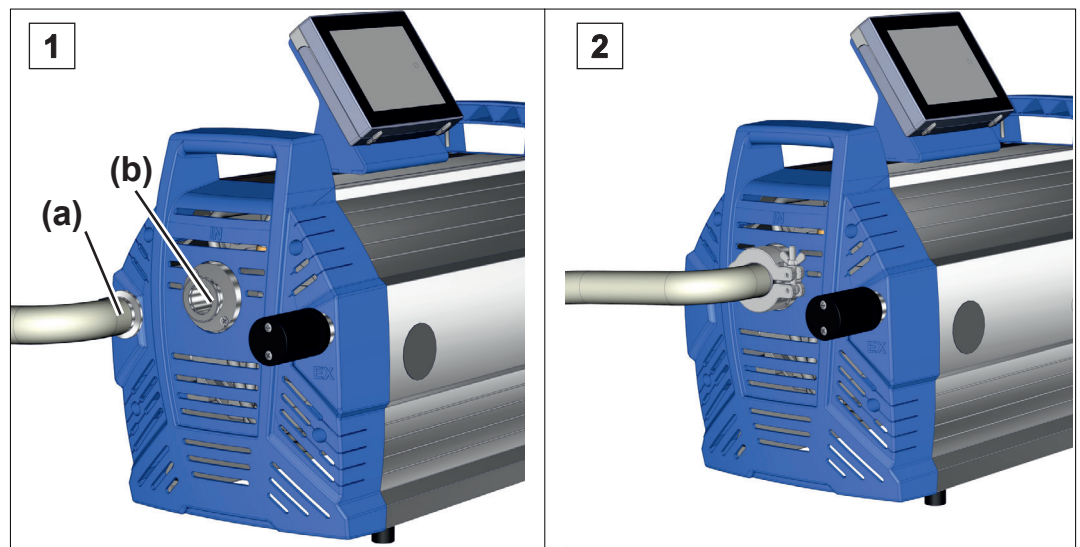

1. Take a vacuum hose (a) with a small flange connection KF DN 25.
2. Attach the vacuum hose to pump inlet (b) with a centering ring and clamping ring.



Observe the following points for optimum results:

- ⇒ Keep the vacuum line as short as you can with as large a cross-section as possible.
- ⇒ Alternatively, you can connect a vacuum hose via an adapter to the hose nozzle DN 15 mm  
→ see accessories in **8.2 Ordering information on page 76**.

### 4.4.3 Outlet connection (EX)

As standard the diaphragm pumps are equipped with a 1/2" thread at the outlet (EX). The included silencer can be replaced optionally by a small flange connection KF DN 16 or a hose nozzle DN 15 mm as outlet connections → see accessories in *8.2 Ordering information on page 76*.

	<b>WARNING</b>
	<p><b>Risk of bursting due to overpressure inside the outlet line.</b></p> <p>Inadmissibly high pressure in the outlet line can cause the vacuum pump to burst or damage seals.</p> <ul style="list-style-type: none"> <li>⇒ The outlet line (exhaust gas, gas outlet) must always be clear and non-pressurized.</li> <li>⇒ Always route the exhaust gas hose with a fall or take measures to prevent condensate from flowing back into the vacuum pump.</li> <li>⇒ Observe the maximum admissible pressures and pressure differences.</li> </ul>

### Modifying the outlet connection (optional)

→ Example  
Assemble a hose nozzle at the outlet

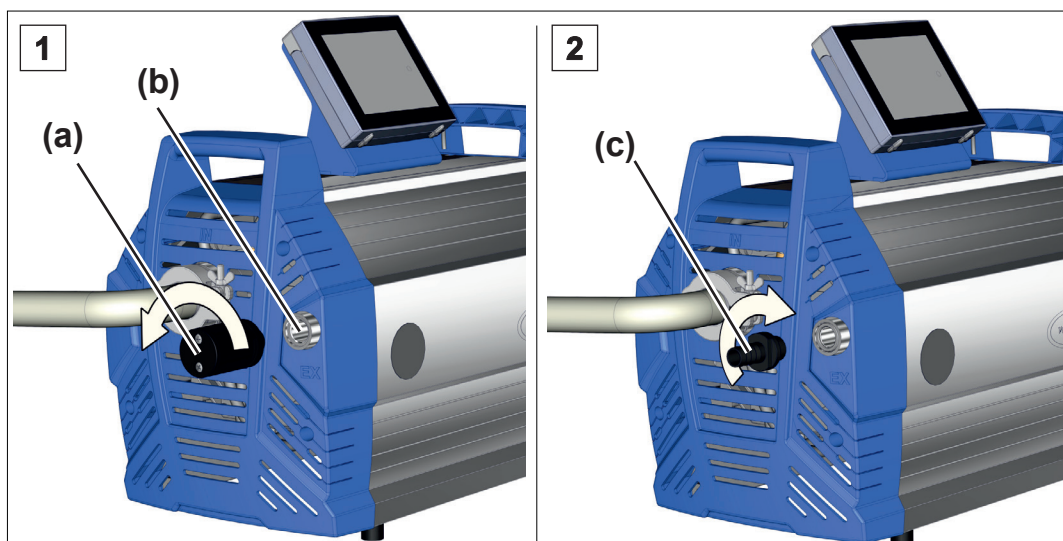

1. Unscrew the silencer (a) from the outlet connection (EX) (b).
2. Assemble a small flange connection KF DN 16 or a hose nozzle DN 15 mm (c) at the outlet connection, thread 1/2".



### Connect the exhaust gas hose (optional)

Connect the exhaust gas hose to the pump, either via the small flange connection KF DN 16 or via the hose nozzle DN 15 mm. The following example describes the connection via hose nozzle.

→ Example  
Exhaust gas connection  
at the outlet EX

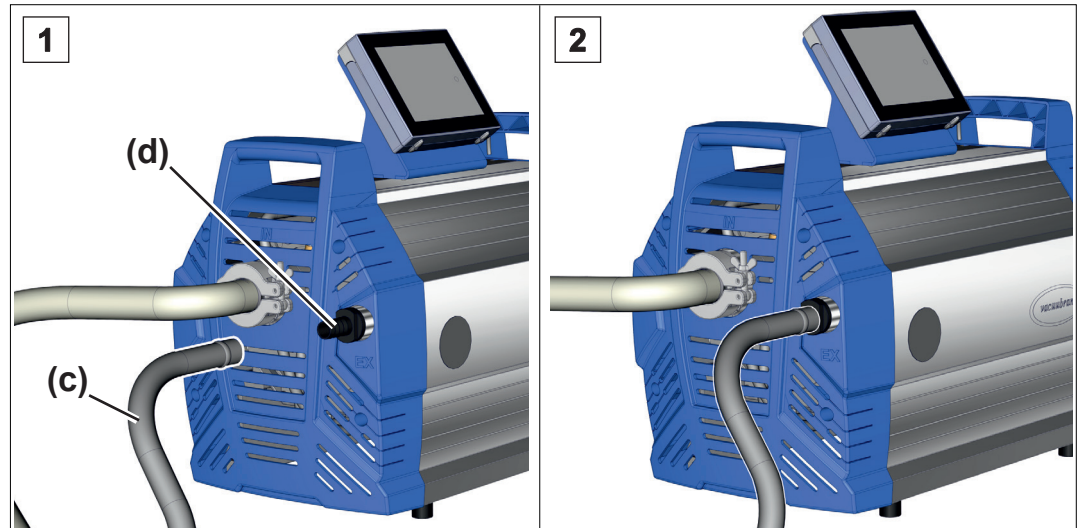

1. Take a vacuum hose (c),  $d_i$  15 mm.
2. Push the exhaust gas hose (d) onto the hose nozzle and lay the hose, if necessary, in a fume hood. If necessary fix the outlet hose, e.g., with a hose clip.

#### 4.4.4 Connect venting valve (optional)

	<b>DANGER</b>
	<p><b>Risk of explosion due to venting with air.</b></p> <p>Depending on the application, venting can cause explosive mixtures to form or other hazardous situations to arise.</p> <ul style="list-style-type: none"><li>⇒ Never vent processes with air which could form an explosive mixture.</li><li>⇒ In the case of flammable substances, use only inert gas for venting, e.g., nitrogen (max. 1.2 bar/900 Torr abs.).</li></ul>

There is *no* venting connection at the diaphragm pump, at the controller or at the enclosed **VACUU·SELECT® Sensor**. You can connect different venting valves, e.g., the valve **VB M-B**, via **VACUU·BUS®** directly to the controller, though. → see accessories in *8.2 Ordering information on page 76*.

### 4.4.5 Electrical connection

#### Electrical connection of the pump

→ Example  
Electrical connection  
diaphragm pump

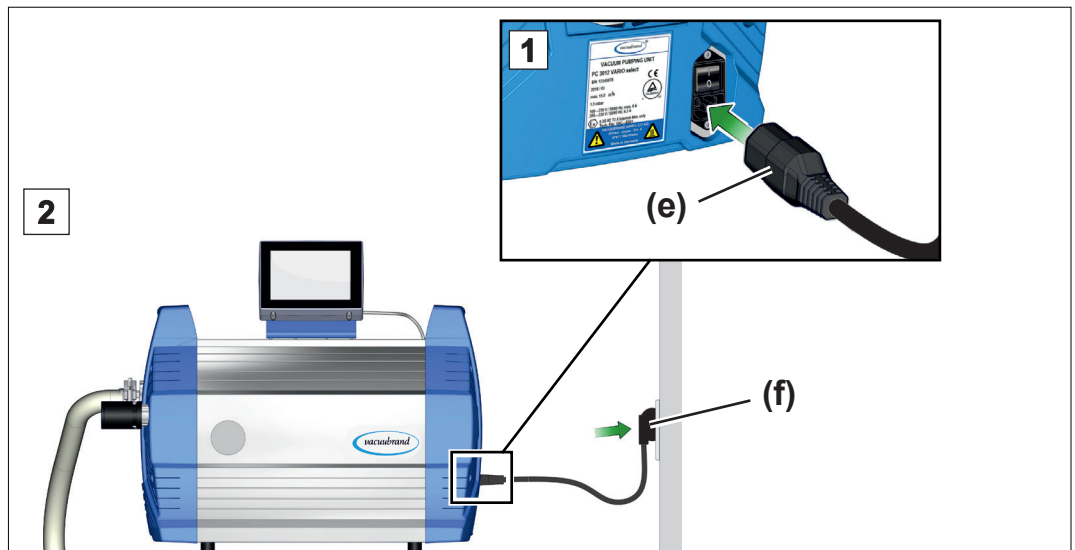

1. Plug the connector (e) on the power cable into the power connection of the vacuum pump.
2. Plug power plug (f) into the power outlet.
  - Vacuum pump electrically connected.

**IMPORTANT!**

⇒ Lay the power cable such that it cannot be damaged by sharp edges, chemicals, or hot surfaces.

#### Power connections with country code

Diagrams of  
standard power  
connections with  
grounding contact

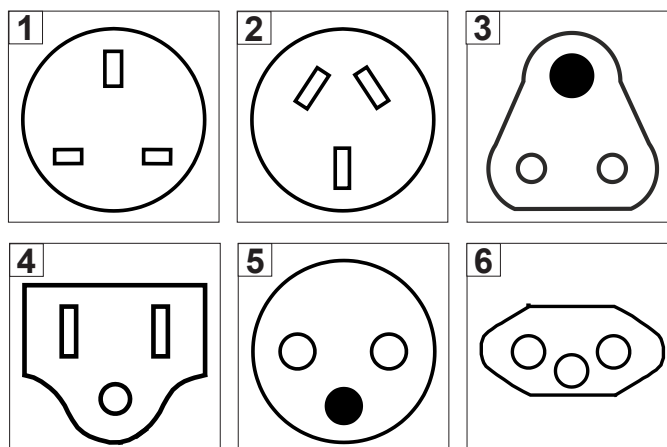

1	UK	4	US
2	CN	5	CEE
3	IND	6	CH

The vacuum pump is delivered ready for use with the appropriate power plug.

**IMPORTANT!**

- ⇒ Use the power plug which fits your power supply.
- ⇒ Do not use multiple sockets connected in series as the power connection.
- ⇒ The mains plug is a disconnecting device to separate the pump from the supply voltage. Ensure that the mains plug is easily accessible at all times to allow the separation of the device from the power supply.

**Connection options for vacuum accessories**

The VACUU·BUS interface functions as the power supply and control line for vacuum accessories.

1. Connect your accessories to your controller via the VACUU·BUS cable.
2. If necessary, increase the range and the number of connections with a suitable Y-adapter and extension cable.

→ *see accessories in chapter 8.2 Ordering information on page 76.*

## 5 Commissioning (operation)

### 5.1 Switch on

Before putting into operation, make sure that the activities described in the chapter Installation and power connection have been carried out properly.

#### Switch pump on

Switch pump on

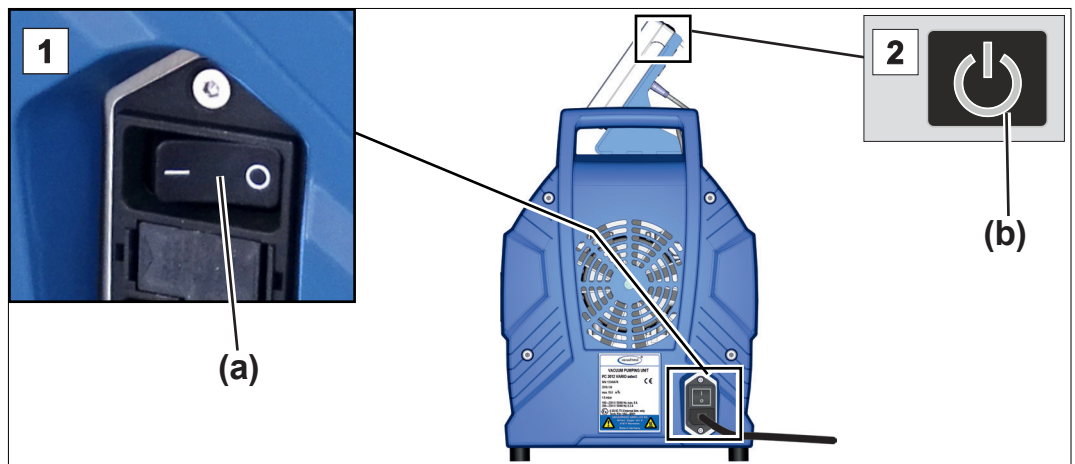

1. Switch rocker switch **(a)** on – switch position I.
2. Press ON/OFF button **(b)** on the controller.
  - ☑ The start screen is displayed.
  - ☑ After approx. 30 seconds, the process screen appears with the operating elements in the controller display.

## 5.2 Operation

Operation with vacuum controller

Apart from the chapters Switch on and Switch off, this manual describes the mechanical structure of the diaphragm pumps.

Operation of the vacuum controller and its functions are described in the separate **VACUU-SELECT** manual.

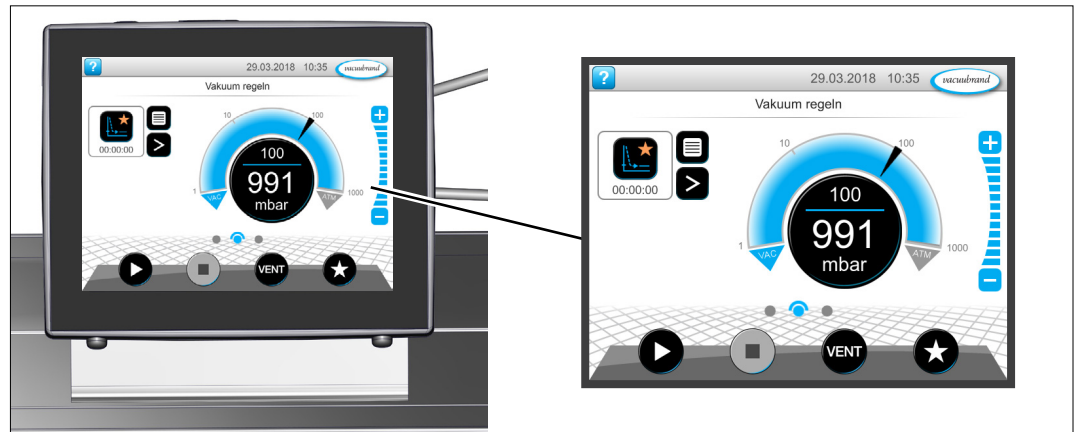

### Process screen

Process screen vacuum controller

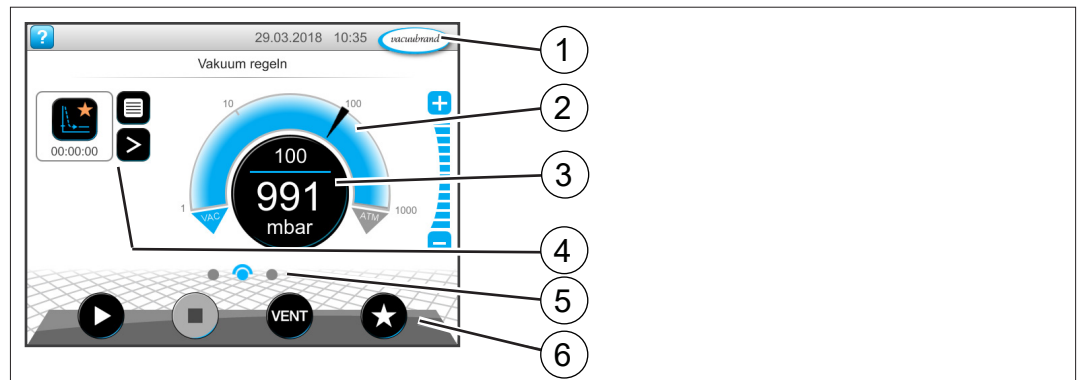

- 1 Status bar
- 2 Analogue pressure display – pressure curve
- 3 Digital pressure reading – pressure value (target value, actual value, pressure unit)
- 4 Process screen with context features
- 5 Screen navigation
- 6 Operating elements for control

Vacuum controller  
operating elements

**Operating elements**

Button		Function
active	locked	
		<b>Start</b> ▶ Start application – only available on the process screen.
		<b>Stop</b> ▶ Stop application – always possible.
		<b>VENT</b> – vent the system (option) ▶ Press button < 2 sec = vent briefly; control continues.
		▶ Press button > 2 sec = vent to atmospheric pressure; vacuum pump is stopped. ▶ Press button during venting = venting is stopped.
		<b>Favorites</b> ▶ View Favorites menu.

\* Button is only displayed if venting valve is connected or activated.

**5.2.1 Operation (→ see description of controller)**

**Start the vacuum controller**

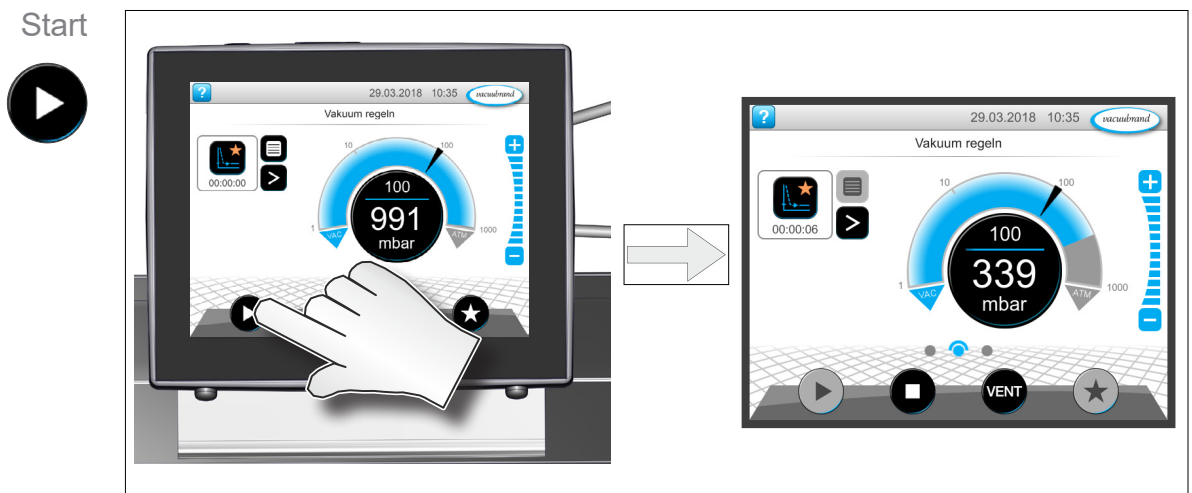

### Stop the vacuum controller

Stop

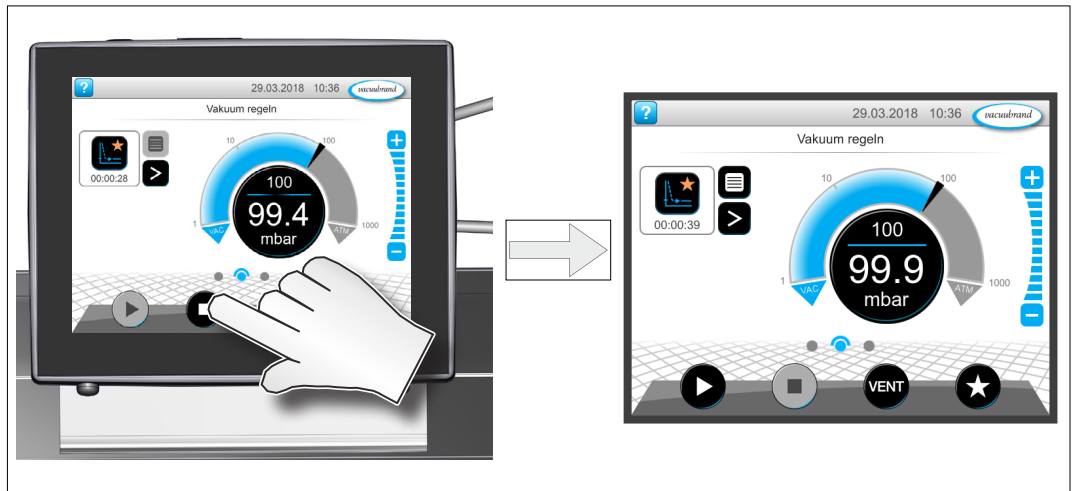

### Venting (option)

Venting

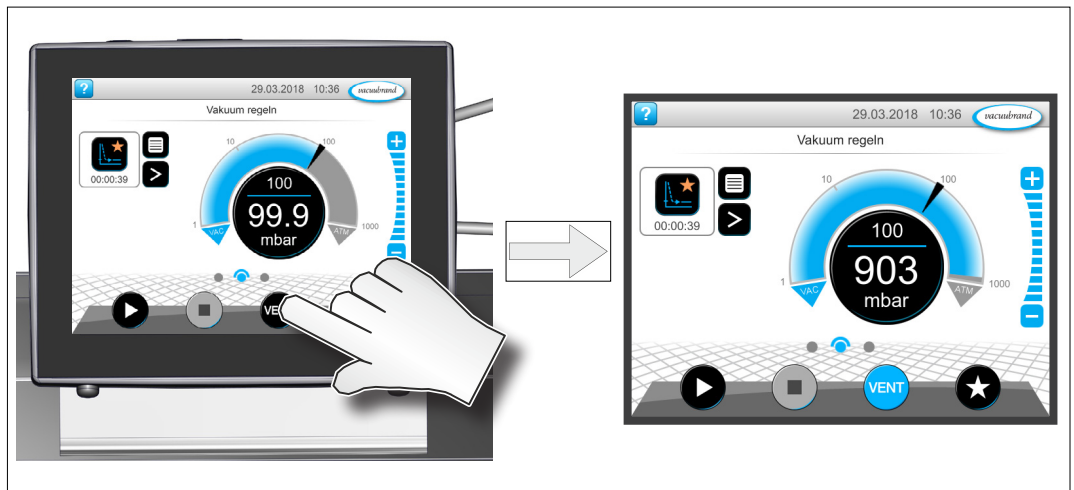



### 5.3 Shutdown (switch off)

#### Take the pump out of operation

Switch pump off

1. Stop the process.
2. Disconnect the pump from the apparatus.
3. Let the vacuum pump run on for about 30 minutes, with open inlet.
  - Condensate and media residues will be flushed out of the vacuum pump.

**IMPORTANT!** ⇒ Prevent deposits and rinse condensate out of the pump.

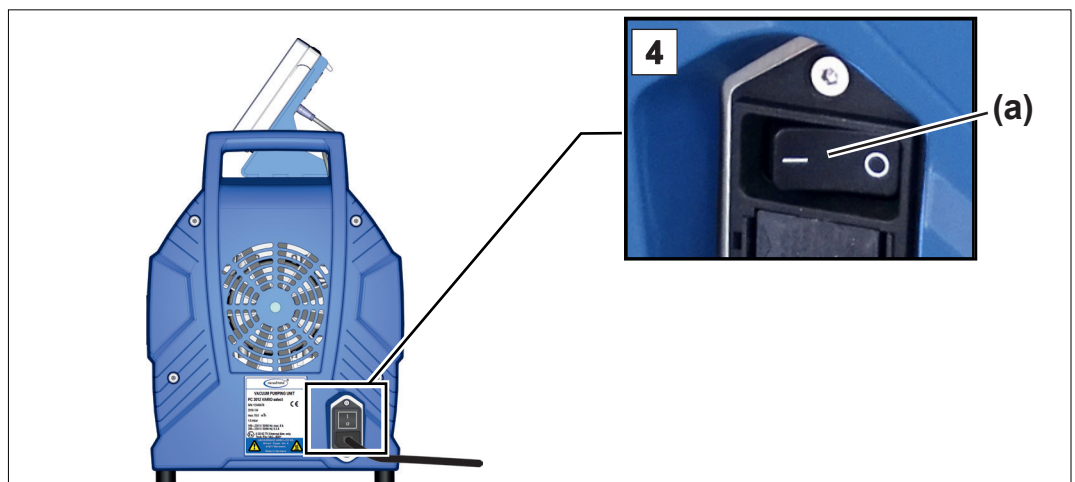

4. Switch rocker switch **(a)** off – switch position **0**.
  - Pump switched off.
5. Check the pump for dirt and damage.

## 5.4 Storage

### Store the vacuum pump

---

1. Clean the vacuum pump if dirty.
2. Recommendation: Perform a preventive maintenance before storing the vacuum pump. This is especially important if it ran more than 15,000 operating hours.
3. Close the suction and outlet lines, e.g., with the transport caps.
4. Package the vacuum pump such that it is protected from dust; enclose desiccants if necessary.
5. Store the vacuum pump in a cool, dry location.

---

**IMPORTANT!**

If damaged parts are stored for operational reasons, these should be clearly identified as **not ready for use**.

---

## 6 Troubleshooting

### 6.1 Technical support

⇒ To identify errors and potential remedies, please refer to the troubleshooting table *Error – Cause – Remedy*.

Technical support

For technical assistance or errors for which you require additional support, please contact your local distributor or our [Service Department](#)<sup>1</sup>.



Operate the machine only when it is in proper working condition.

- ⇒ Observe the recommended maintenance intervals to ensure a fully functional system.
- ⇒ Send defective devices to our Service Department or your local supplier for repair!

### 6.2 Error – Cause – Remedy

Error – Cause – Remedy

Error	Possible cause	✓ Remedy	Personnel
Readings deviate from the reference standard	<ul style="list-style-type: none"> <li>▶ Vacuum sensor dirty.</li> <li>▶ Moisture in the sensor.</li> <li>▶ Sensor defective.</li> <li>▶ Sensor measures incorrectly.</li> </ul>	<ul style="list-style-type: none"> <li>✓ Clean sensor measuring chamber.</li> <li>✓ Allow sensor measuring chamber to dry, e.g., by pumping.</li> <li>✓ Calibrate sensor with reference gauge.</li> <li>✓ Replace defective components.</li> </ul>	Specialist
Sensor does not pass on measured value	<ul style="list-style-type: none"> <li>▶ No voltage applied.</li> <li>▶ VACUU·BUS plug-in connection or cables defective or not connected.</li> </ul>	<ul style="list-style-type: none"> <li>✓ Check VACUU·BUS plug-in connection and cables to the controller.</li> </ul>	Operator
	<ul style="list-style-type: none"> <li>▶ Sensor defective.</li> </ul>	<ul style="list-style-type: none"> <li>✓ Replace defective components.</li> </ul>	Specialist

<sup>1</sup> -> Phone: +49 9342 808-5660, fax: +49 9342 808-5555, [service@vacuubrand.com](mailto:service@vacuubrand.com)

Error – Cause –  
Remedy



Error	▶ Possible cause	✓ Remedy	Personnel
Venting valve (optional) does not switch	<ul style="list-style-type: none"> <li>▶ No voltage applied.</li> <li>▶ VACUU·BUS plug-in connection or cables defective or not connected.</li> <li>▶ Venting valve dirty.</li> </ul>	<ul style="list-style-type: none"> <li>✓ Check VACUU·BUS plug-in connection and cables to the controller.</li> <li>✓ Clean venting valve.</li> <li>✓ Perform component detection in VACUU·SELECT – see: Main menu/ Administration/ VACUU·BUS.</li> <li>✓ If necessary, use another external venting valve.</li> </ul>	Specialist
Vacuum pump does not start	<ul style="list-style-type: none"> <li>▶ Overpressure in the outlet line.</li> <li>▶ Condensation in the vacuum pump.</li> </ul>	<ul style="list-style-type: none"> <li>✓ Open the outlet line, check the silencer.</li> <li>✓ Ensure clear passage.</li> </ul>	Operator
	<ul style="list-style-type: none"> <li>▶ Pump switched off.</li> <li>▶ Power plug not correctly plugged in or pulled out.</li> <li>▶ VACUU·BUS plug-in connection or cables defective or not connected.</li> </ul>	<ul style="list-style-type: none"> <li>✓ Switch pump on using rocker switch.</li> <li>✓ Check power supply and cable.</li> <li>✓ Check VACUU·BUS plug-in connection and cables to the controller.</li> </ul>	Operator

Error – Cause –  
Remedy

Error	▶ Possible cause	✓ Remedy	Personnel
Vacuum pump does not start	<ul style="list-style-type: none"> <li>▶ Motor overloaded.</li> <li>▶ Motor protection has been triggered.</li> </ul>	<ul style="list-style-type: none"> <li>✓ Allow the motor to cool down.</li> <li>✓ Clear error manually: Acknowledge the error message at the controller → Switch off pump or unplug pump from power supply → Determine and eliminate cause of error → Allow pump to cool down and switch vacuum pump back on.</li> </ul>	Specialist
No or very little suction power	▶ Leak in the suction line or in the apparatus.	✓ Check suction line and apparatus for leaks.	Operator
	▶ Vacuum line too long or cross-section too small.	✓ Use a shorter vacuum line with a larger cross-section.	Operator
	▶ Condensate inside the vacuum pump.	✓ Allow vacuum pump to run for a few minutes with the suction nozzle open.	Operator
	▶ Deposits inside the vacuum pump.	✓ Clean and check pump heads.	Specialist
	▶ Diaphragms or valves defective.	✓ Replace diaphragms and valves.	Specialist
▶ High level of vapor generated in the process.	✓ Check process parameter.	Specialist	

Error	▶ Possible cause	✓ Remedy	Personnel
No display	<ul style="list-style-type: none"> <li>▶ Pump switched off.</li> <li>▶ Power plug not correctly plugged in or pulled out.</li> <li>▶ VACUU·BUS plug-in connection or cables defective or not connected.</li> <li>▶ Controller switched off or defective.</li> </ul>	<ul style="list-style-type: none"> <li>✓ Switch pump on using rocker switch.</li> <li>✓ Switch on controller.</li> <li>✓ Check power supply and cable.</li> <li>✓ Check VACUU·BUS plug-in connection and cables to the controller.</li> </ul>	Operator
		<ul style="list-style-type: none"> <li>✓ Replace defective components</li> </ul>	Specialist
Measured leakage current too high	<ul style="list-style-type: none"> <li>▶ The pump is equipped with a frequency converter and a switching power supply.</li> </ul>	<ul style="list-style-type: none"> <li>✓ Use a suitable measuring method / measuring device.</li> </ul>	Specialist
Loud operating noises	<ul style="list-style-type: none"> <li>▶ No silencer or hose mounted at the outlet.</li> <li>▶ Outlet line open.</li> </ul>	<ul style="list-style-type: none"> <li>✓ Check silencer or hose and install correctly.</li> <li>✓ Check outlet line connections.</li> <li>✓ Connect the outlet line to an extraction system or fume hood.</li> </ul>	Operator
	<ul style="list-style-type: none"> <li>▶ Ball bearing defective.</li> </ul>	<ul style="list-style-type: none"> <li>✓ Service the vacuum pump and replace defective parts or send in the device.</li> </ul>	Specialist

## 7 Cleaning and maintenance

	<b>WARNING</b>
	<b>Danger due to electrical voltage.</b> <ul style="list-style-type: none"><li>⇒ Switch the device off before cleaning or maintenance work.</li><li>⇒ Unplug the power plug from the socket.</li></ul>
	<b>Risk from contaminated parts.</b> <p>Pumping hazardous media can result in hazardous substances adhering to internal parts of the pump.</p> <ul style="list-style-type: none"><li>⇒ Wear your personal protective equipment, e.g., protective gloves, eye protection and, if necessary, respiratory protection.</li><li>⇒ Decontaminate the vacuum pump before opening it. If necessary have decontamination carried out by an external service provider.</li><li>⇒ Take safety precautions according to your instructions for handling hazardous substances.</li></ul>

### NOTICE

**Damage possible if work is performed incorrectly.**

- ⇒ Have maintenance work performed by a trained professional or at least by a trained person.
- ⇒ Recommendation: Before carrying out maintenance for the first time, please read through all the instructions to get an overview of the required service work.

## 7.1 Information on service work

### Recommended maintenance intervals

Maintenance intervals*	if required	15000 h
Replace diaphragms		X
Replace valves		X
Replace O-rings		X
Clean or replace molded PTFE-hose	X	
Clean the vacuum pump	X	

\* Recommended maintenance interval after hours of operation and under normal operating conditions; depending on the environment and area of application, we advise performing cleaning and maintenance as needed.

### Recommended aids

→ Example  
Recommended aids  
for cleaning and  
maintenance



Protective gloves

#### **IMPORTANT!**

⇒ Always wear your personal protective equipment when performing activities which may bring you into contact with hazardous substances.



Tools needed for maintenance

→ Example  
Tool



Nr	Tool	Size
1	<b>Service kit</b> Service kit MD 12 / MV 10 NT VARIO select #20696827 <i>or</i> Service kit ME 16 NT VARIO select #20696819	1x  1x
2	<b>Diaphragm wrench #20636554</b>	SW66
3	<b>Flat nose pliers</b> Close hose clamps	
4	<b>Flat-head screwdriver</b> Open hose clamps	Size 1
5	<b>Phillips screwdriver</b> Screw fittings, controller base Screw fittings, distributor, outlet holder	Size 1 Size 2
6	<b>Hex key</b> Screw fittings, side panels Screw fittings, housing cover Screw fittings, housing sections with handle Screw fittings, side panel retaining plates	Size 5 Size 5 Size 4 Size 4
7	<b>Torque wrench, adjustable 2–10 Nm</b>	

## 7.2 Cleaning

**IMPORTANT!**

This chapter does not contain descriptions for decontamination of the product. This chapter describes simple measures for cleaning and care.

⇒ Before cleaning, switch off the diaphragm pump.

### 7.2.1 Diaphragm pump

#### Clean the surfaces



Clean dirty surfaces with a clean, slightly damp cloth. We recommend using water or mild soapy water to moisten the cloth.

### 7.2.2 Clean or replace molded PTFE hoses

Maintenance provides the opportunity to check the components of the diaphragm pump, including the hoses.

⇒ Clean the inside of very dirty molded hoses, e.g., using a pipe cleaner or similar.

⇒ Replace brittle and defective molded hoses.

### 7.2.3 Clean or replace the controller

During maintenance, the controller can be disconnected and removed.

#### Clean the surfaces



⇒ Clean dirty surfaces with a clean, slightly damp cloth. We recommend using water or mild soapy water to moisten the cloth.

⇒ Reattach the controller after maintenance work has been completed.

## 7.3 Diaphragm pump maintenance

### 7.3.1 Maintenance items

#### Servicing positions

→ Example  
Diaphragm pump,  
front,  
semi-transparent  
view

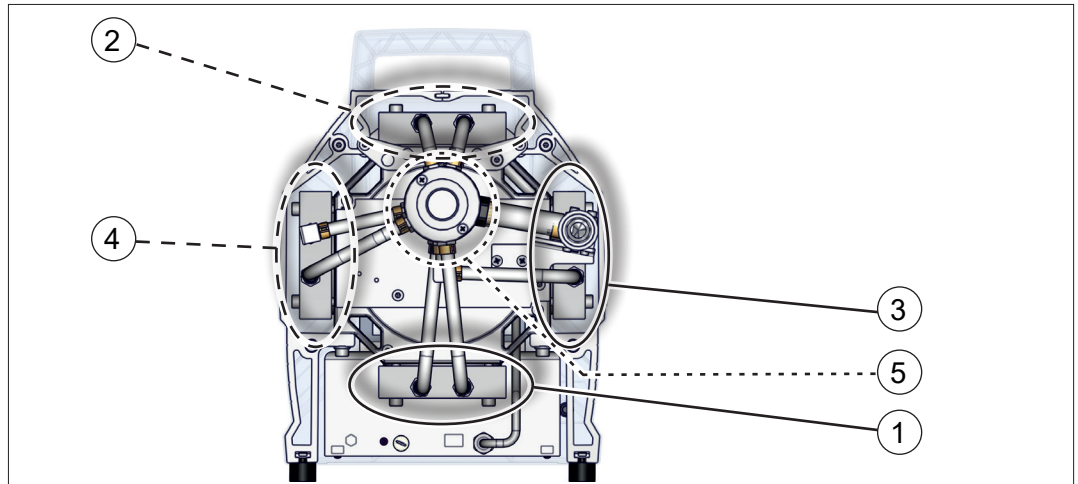

Meaning

#### Maintenance items and sequence

- |   |   |
|---|---|
| 1 | Bottom pump head pair                             |
| 2 | Top pump head pair                                |
| 3 | Right pump head pair                              |
| 4 | Left pump head pair                               |
| 5 | Suction/pressure distributor (only MV 10 / MD 12) |



Straightforward maintenance due to split work steps. Observe the recommended sequence of maintenance steps according to the table:

- ⇒ On one pump head pair, first replace the diaphragms.
- ⇒ Then change the inlet/outlet valves.
- ⇒ Repeat these steps on the next pump head pair.
- ⇒ Then replace the O-ring and the pressure relief valve in the suction/pressure distributor.

### 7.3.2 Preparation

Disassemble the controller and base

→ see also chapter: *4.3 Controller base on page 28*

#### Disassemble the device and housing sections

Disassemble the front housing section

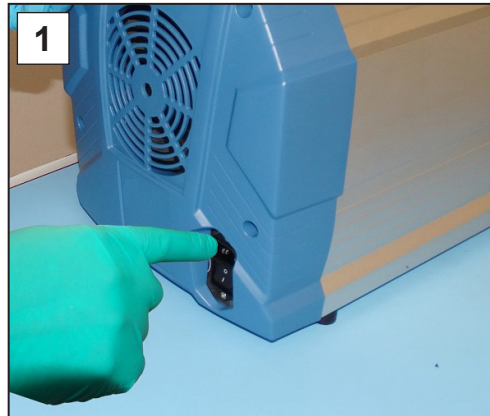

1. Switch the diaphragm pump off and unplug the power plug.

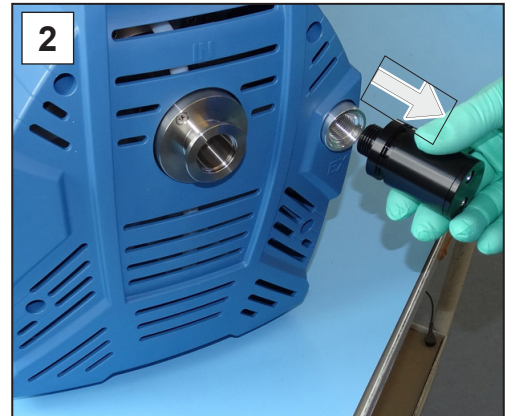

2. Unscrew the silencer from the outlet.



3. Unscrew the 4 screws from the front housing section; hex key size 4.

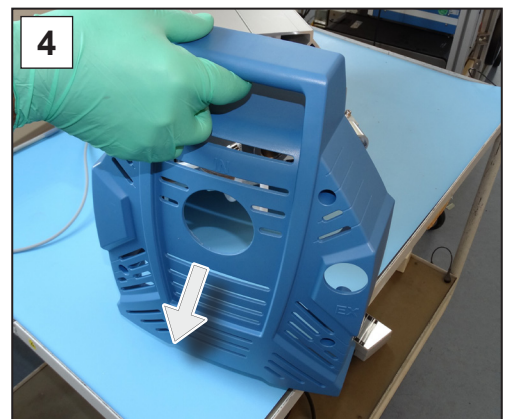

4. Remove the housing section and set it aside.



**5.** Unscrew the 4 screws from the rear housing section; hex key size 4.

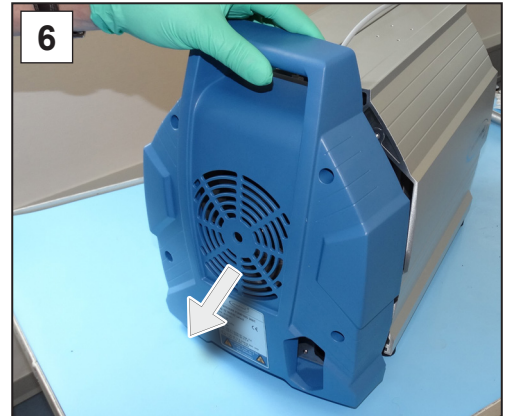

**6.** Remove the housing section and set it aside.

**Remove the side panel**

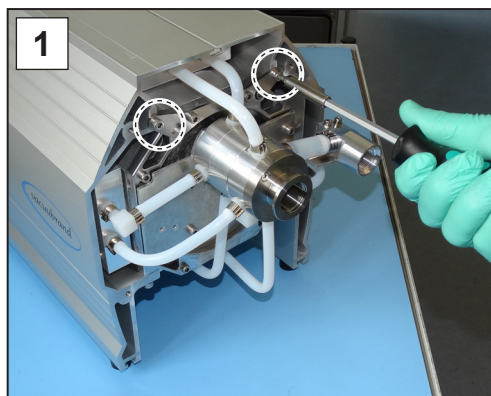

**1.** Unscrew the 2 outer screws from the side panel retaining plate at the front; hex key size 4

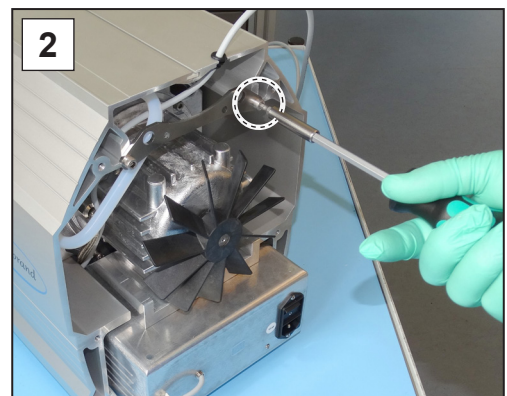

**2.** Unscrew the right screw from the side panel retaining plate at the rear; hex key size 4

Remove the left side panel

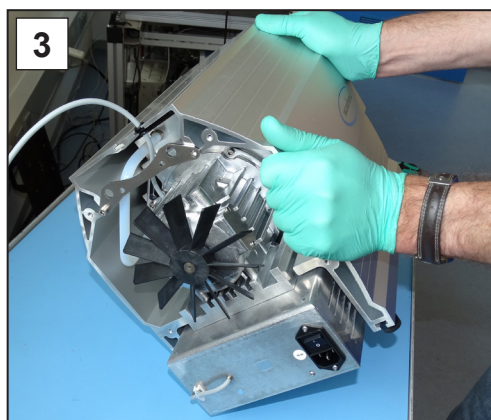

**3.** Place the pump carefully on its side.

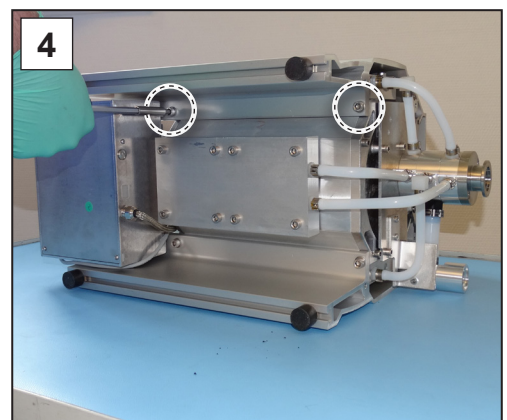

**4.** Unscrew the screw fittings from the side panel; hex key size 5.

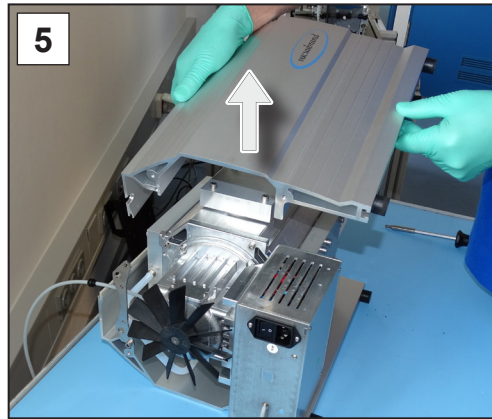

**5.** Lift the left side panel off the pump. Place the pump carefully on its other side.

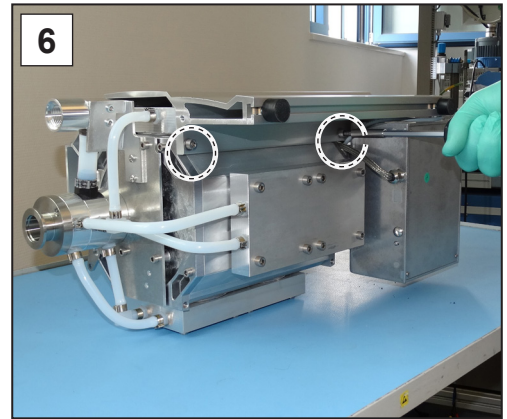

**6.** Unscrew the screw fittings from the side panel; hex key size 5.

Remove the right side panel

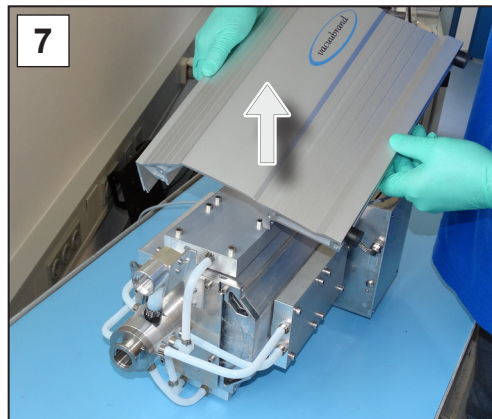

**7.** Lift the right side panel off the pump.

### 7.3.3 Replacing the diaphragms and valves

#### Exploded drawing of pump head (example)

Exploded-drawing  
pump head

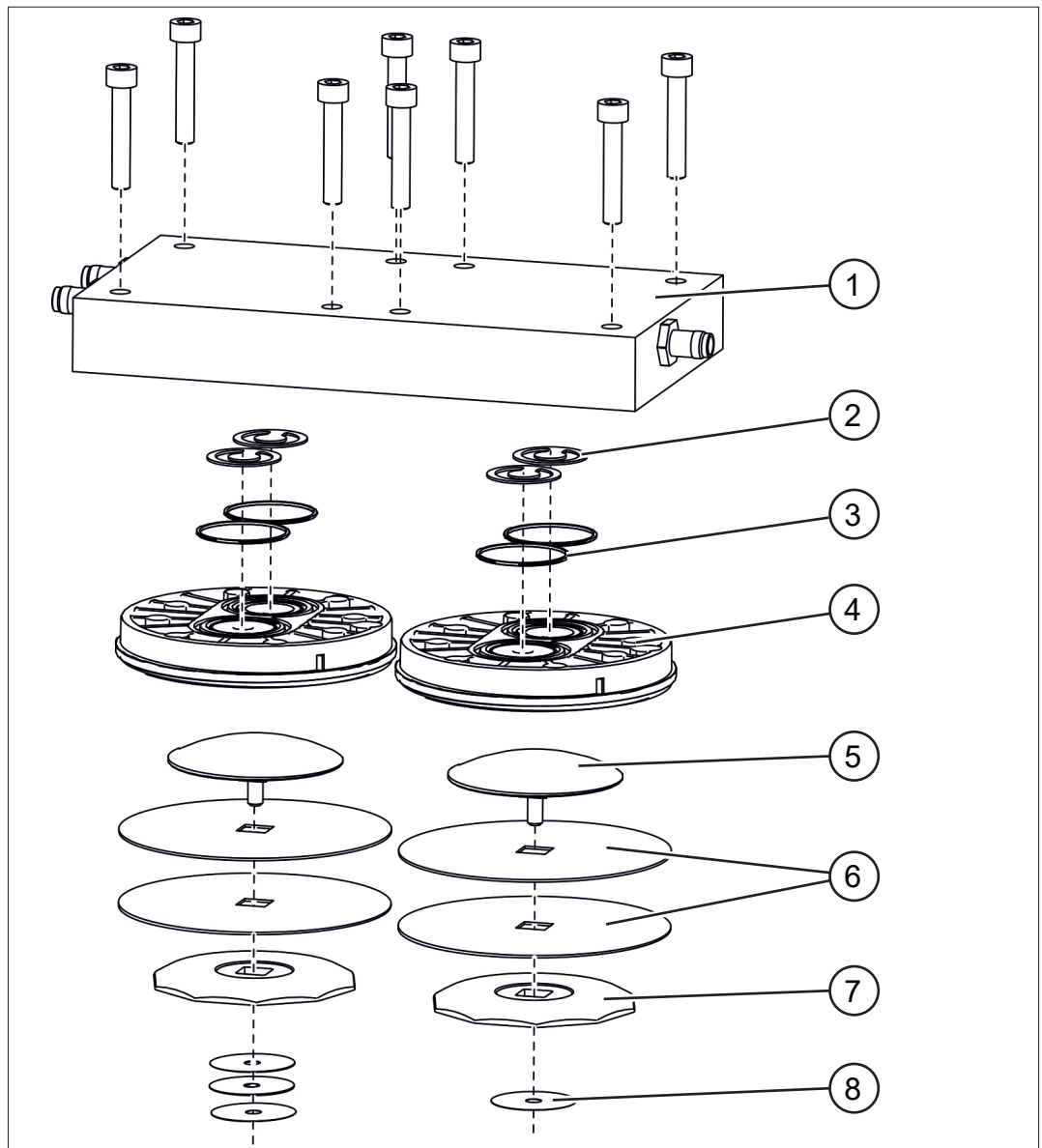

#### Valve maintenance

- 1 Housing cover
- 2 Valves
- 3 O-rings size 28 x 1,5

#### Diaphragm maintenance

- 4 Head cover
- 5 Diaphragm clamping disc with square-head screw
- 6 Double diaphragm, 2 diaphragms per pump head
- 7 Diaphragm support disc
- 8 Spacer discs, max. 4 per pump head

## Bottom pump head pair

→ Example  
Bottom pump head  
pair

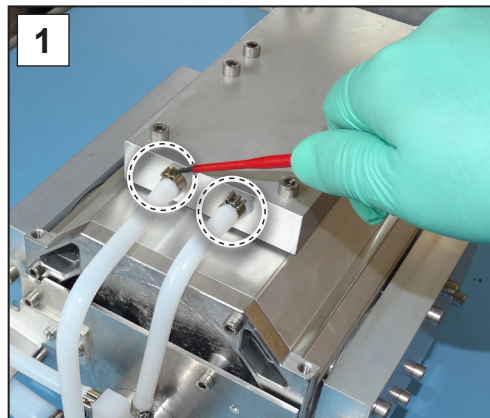

**1.** Turn the pump to bring the bottom pump head pair to the top. Open the hose clips on the hoses. Flat-head screwdriver size 1.

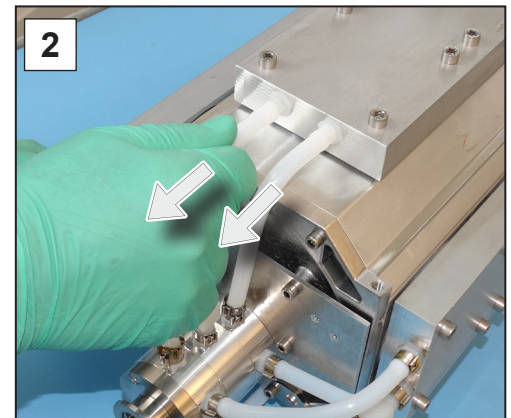

**2.** Pull off the molded hoses.

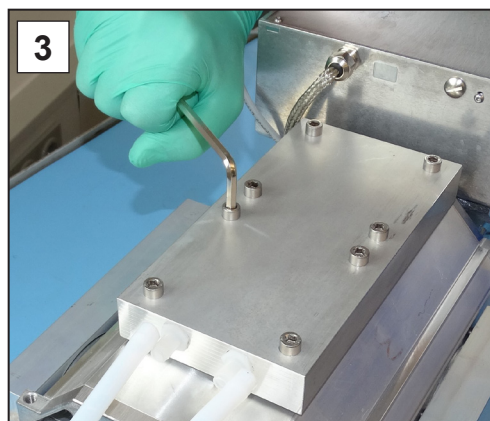

**3.** Unscrew the socket head screws from the housing cover. Hex key size 5.

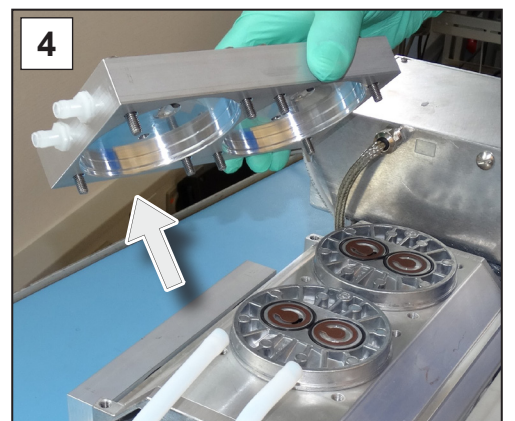

**4.** Remove the housing cover.

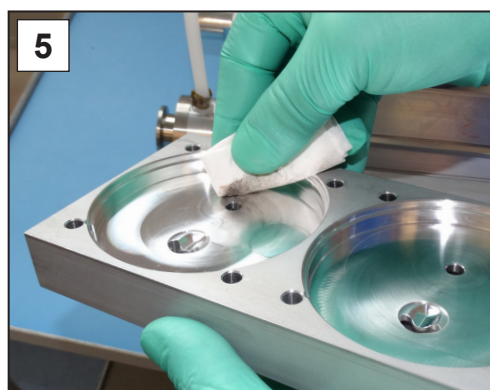

**5.** Check the surfaces for dirt. Clean dirty surfaces carefully.



Remove valves and  
O-rings

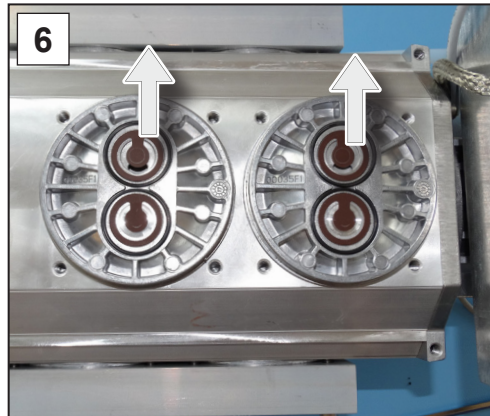

**6.** Carefully remove the used valves.



**7.** Carefully remove the used O-rings.



**8.** Remove the head covers.  
Check the surfaces for dirt.  
Clean dirty surfaces carefully.

## Replace the diaphragms

→ Example  
Replacing the  
diaphragms

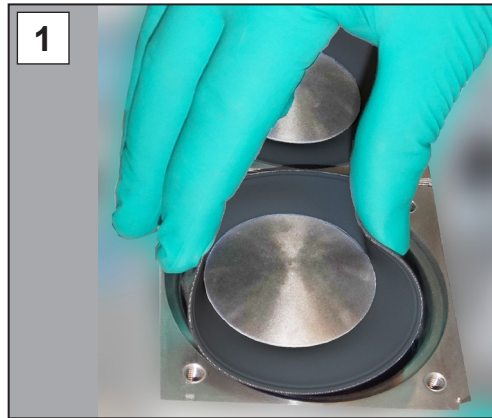

1. Lift the diaphragm upwards on either side.



2. Carefully position the diaphragm wrench on the diaphragm support disc and unscrew the assembly with the diaphragm wrench attached.



3. Lift the diaphragm, along with all the parts, out of the vacuum pump.



4. If the spacer discs adhere to the connecting rod, remove them carefully.

### **IMPORTANT!**

- ⇒ Never let drop spacer discs into the aluminum housing.
- ⇒ Keep the spacer discs. It is essential to reinsert the same number of spacer discs.

→ Example  
Replacing the  
diaphragms



5. Pull out the diaphragm clamp-  
ing disc and remove the used  
diaphragm.



6. Place the new diaphragm over  
the square head of the clamp-  
ing disc.

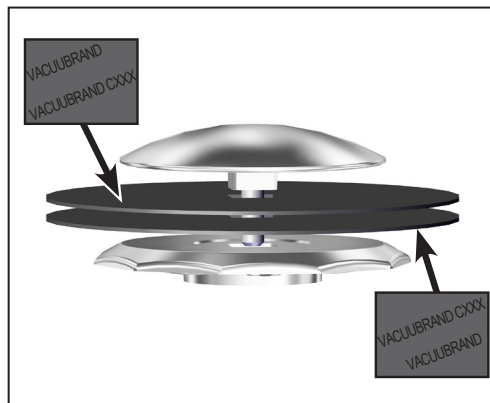

**IMPORTANT!**

⇒ Double diaphragm comprising 2 single diaphragms. Use the diaphragms only in pairs. The printed surfaces of the diaphragms have to face outwards.

⇒ Pay special attention to correct positioning on the square head.



7. Place all spacer discs on the  
thread pin.



8. Secure the diaphragm assem-  
bly inside the diaphragm  
wrench.



**9.** Hold the spacer discs firmly and place all the components carefully on the connecting rod thread.

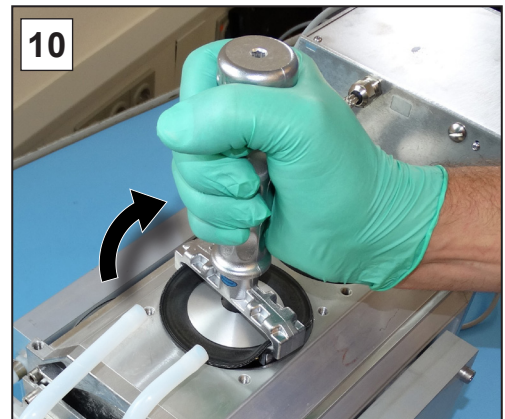

**10.** Initially tighten the assembly with the diaphragm wrench by hand.



**11.** Then position a torque wrench with socket head bit on the diaphragm wrench and tighten the assembly to 6 Nm.

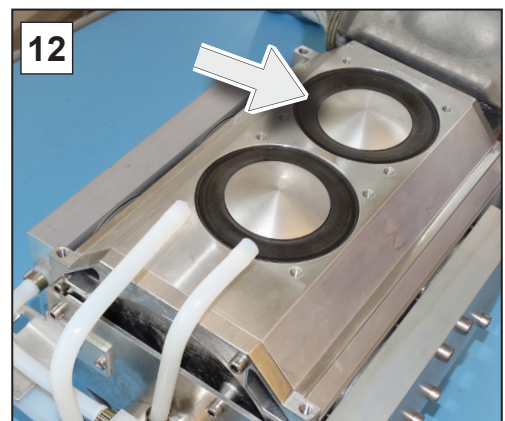

**12.** Repeat steps 1-11 for replacing the next diaphragm.

**Insert valves**

→ Example  
Insert valves and  
O-rings

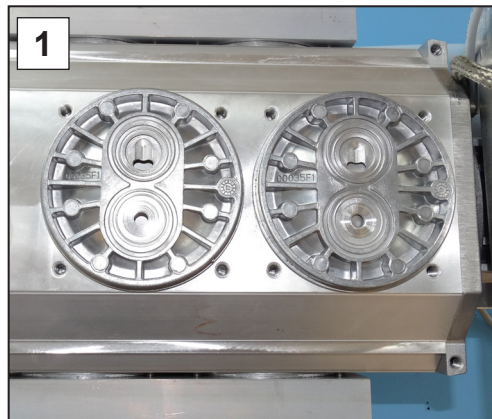

**1.** Place the head covers onto the diaphragms. Pay attention to the correct orientation of the head covers.

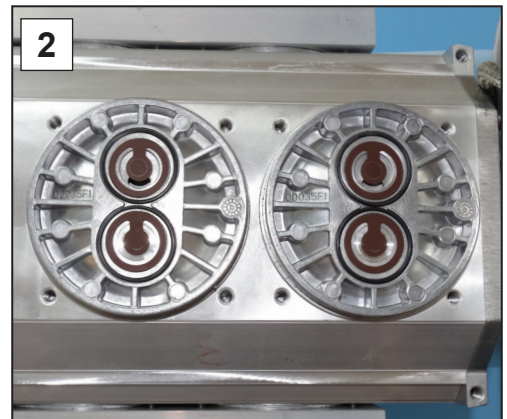

**2.** Insert the new O-rings into the grooves. Insert the new valves. Pay attention to the correct orientation of the valves.

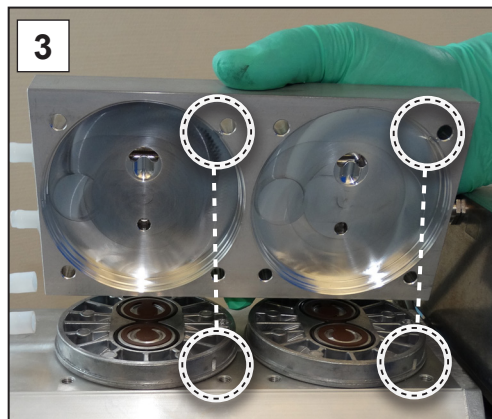

**3.** Take the housing cover and align the head covers. The nibs at the head covers have to lock into the notches of the housing cover.

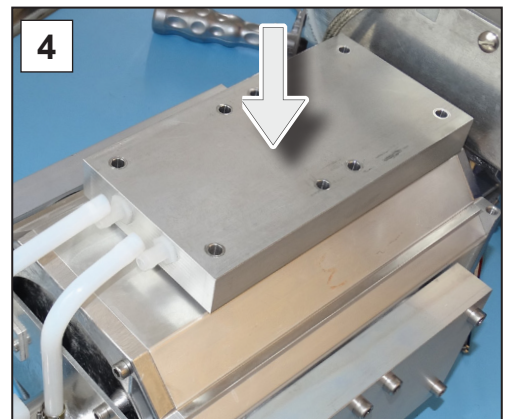

**4.** Put the housing cover on properly.

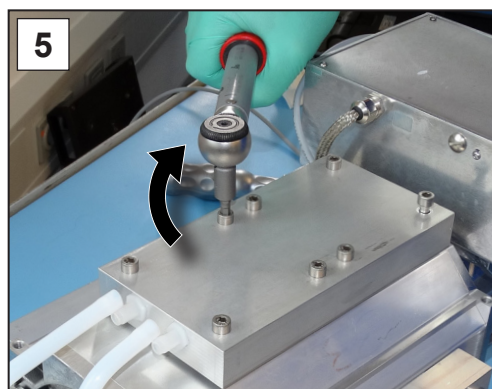

**5.** Screw in the screw fittings crosswise. Tighten the screw fittings with a torque wrench to 6 Nm; hex key size 5.

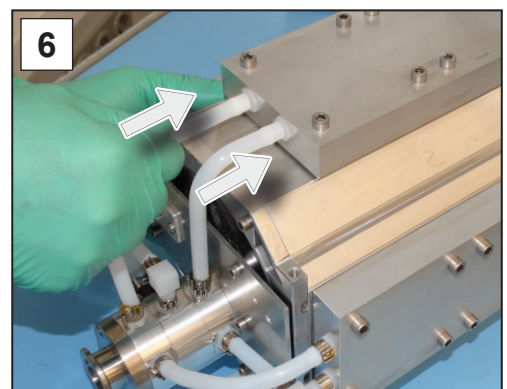

**6.** Slide the molded hoses back onto the hose nozzles.

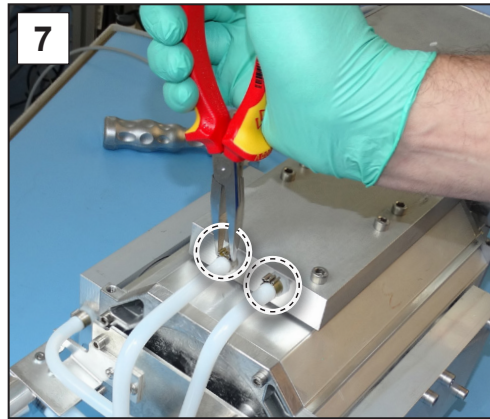

7. Secure the hose clips on the hose nozzles, e.g., with flat nose pliers.

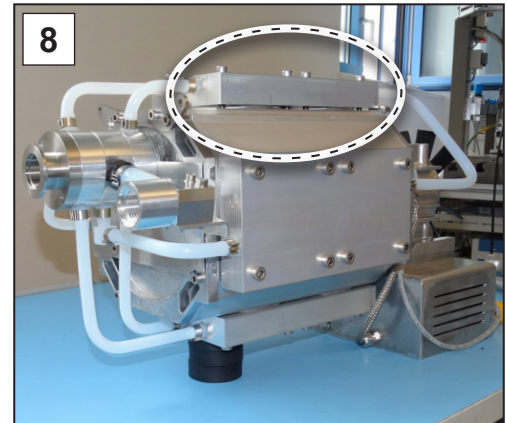

8. Turn the pump to bring the top pump head pair to the top. Support the pump, e. g., with rigid foam.

Maintain the top, right and left pump head pairs

⇒ Follow the same procedure to replace the diaphragms and valves of the top pump head pair as described for the **Bottom pump head pair, on pages 56 to 62.**

⇒ Subsequently replace one by one the diaphragms and valves of the right and left pump head pair.

## Assemble the device and housing sections

Mount the side panel

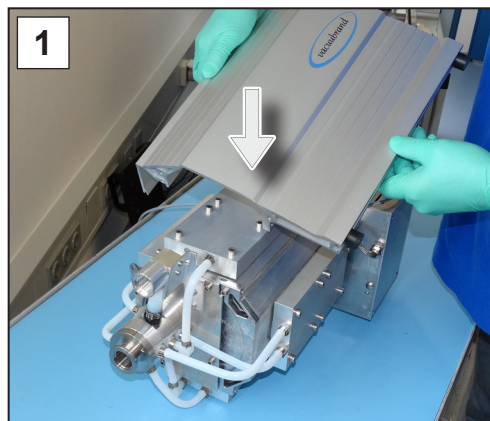

**1.** Place the side panel on the pump.

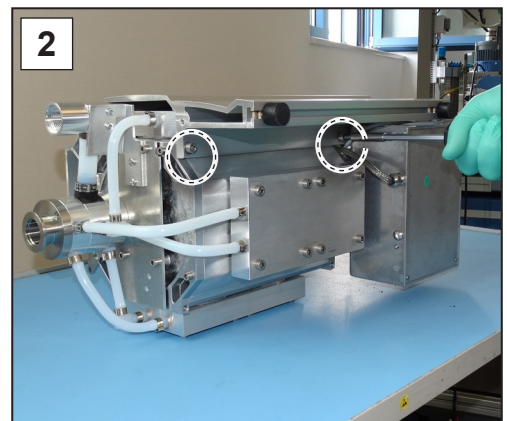

**2.** Wind the screw fittings into the side panel; hex key size 5.

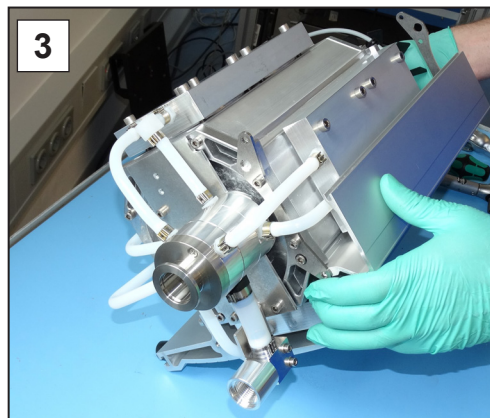

**3.** Turn the pump to the top.

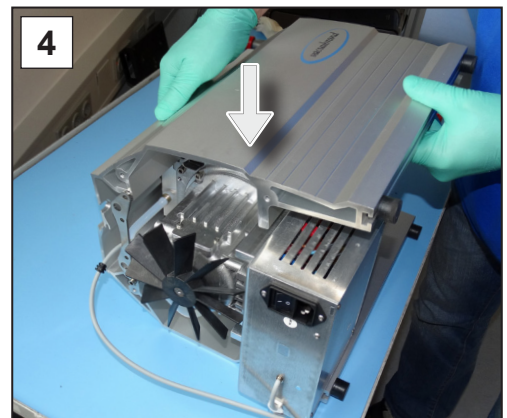

**4.** Place the side panel on the pump.

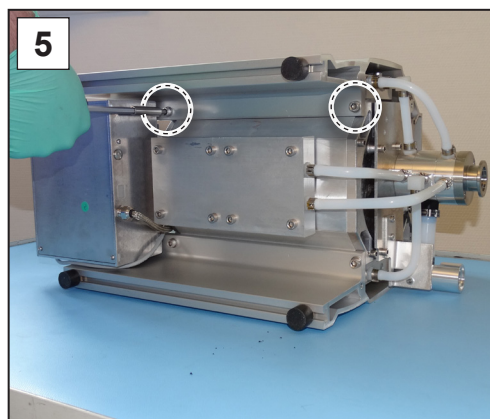

**5.** Wind the screw fittings into the side panel; hex key size 5.

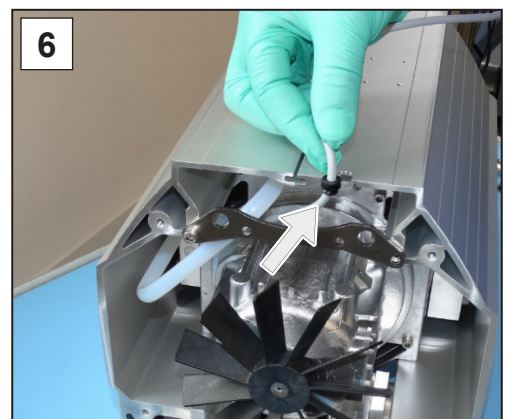

**6.** Secure the cable in the rear recess.

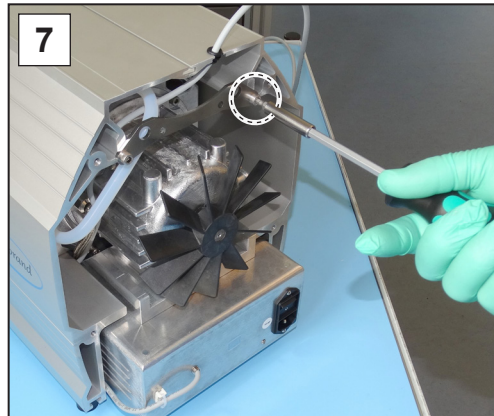

**7.** Wind in the screw of the side panel retaining plate at the rear; hex key size 4.

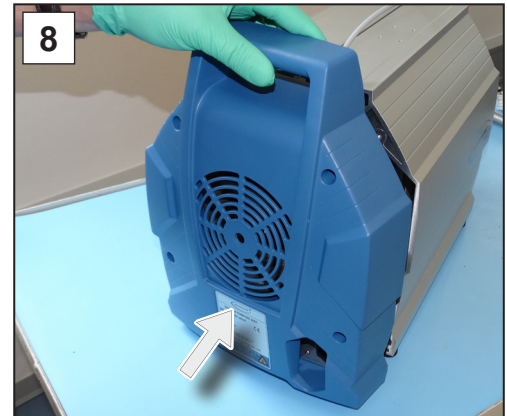

**8.** Place the rear housing section.

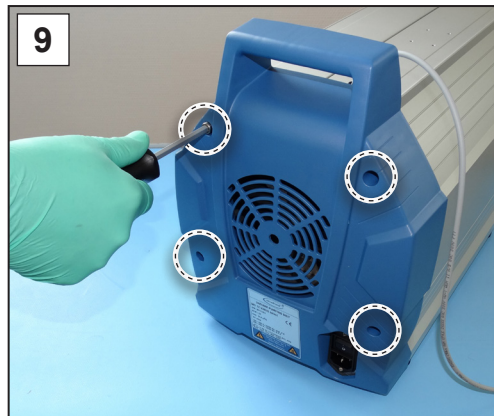

**9.** Wind in the screws of the housing section; hex key size 4.

⇒ Prior to mounting the front housing section the suction/pressure distributor of the pumps MD 12 and MV 10 NT VARIO select has to be maintained.



**Suction/pressure distributor maintenance**

Maintenance of suction/pressure distributor

**This description only applies to diaphragm pumps MD 12 and MV 10 NT VARIO select.**

**Exploded drawing of suction/pressure distributor (example)**

→ Example Pressure relief valve

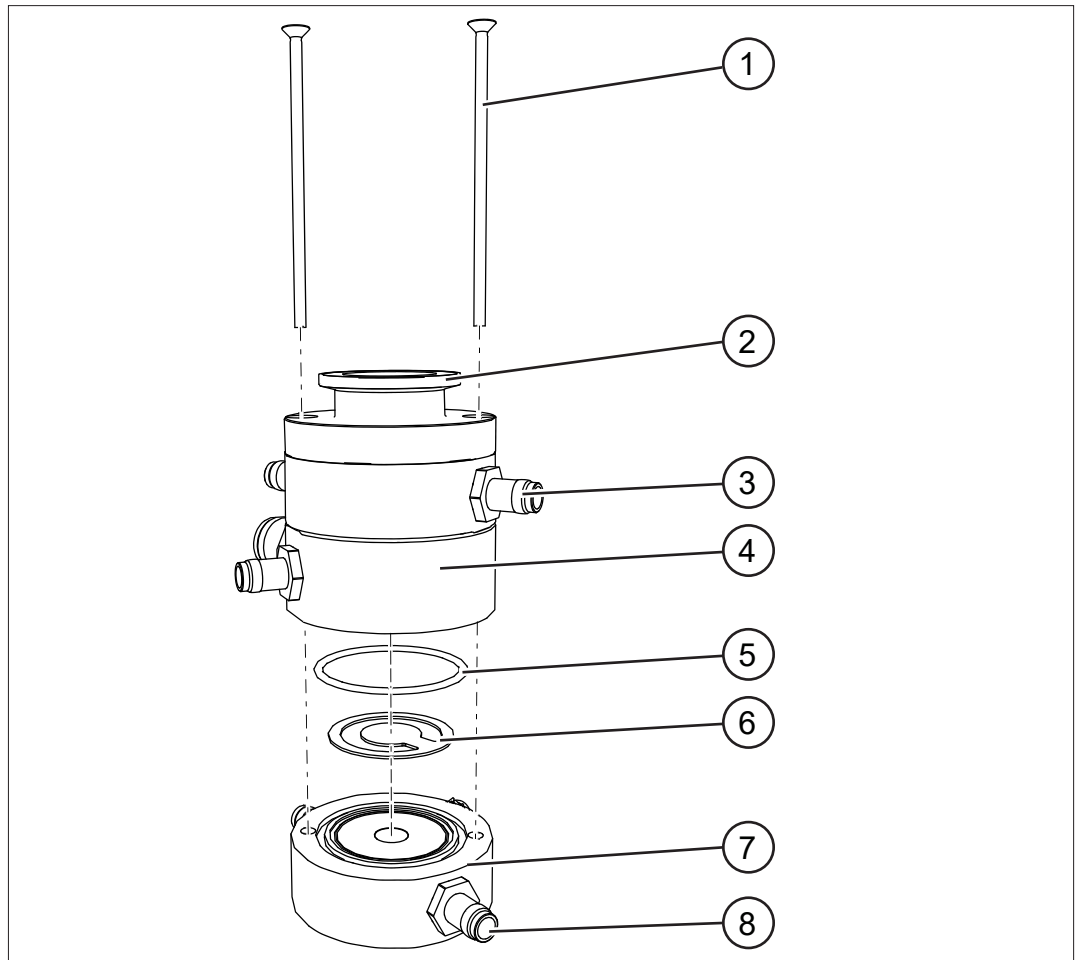

**Maintenance overpressure relief valve + O-ring**

- 1 Countersunk screw M4x80
- 2 Connection DN 25
- 3 Hose nozzle
- 4 Suction distributor
- 5 O-ring 40 x 2
- 6 Pressure relief valve D37
- 7 Pressure distributor
- 8 Hose nozzle

## Replace pressure relief valve + O-ring

Replace pressure relief valve and O-ring

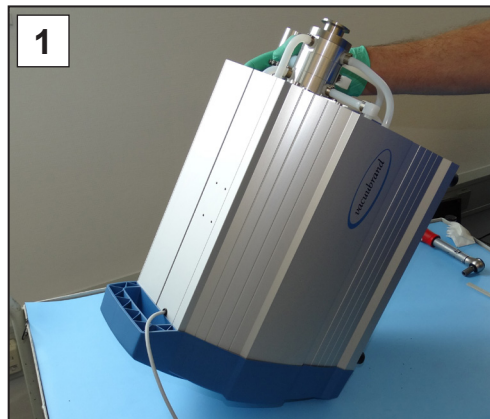

**1.** Place the vacuum pump on a clean, stable surface as shown.

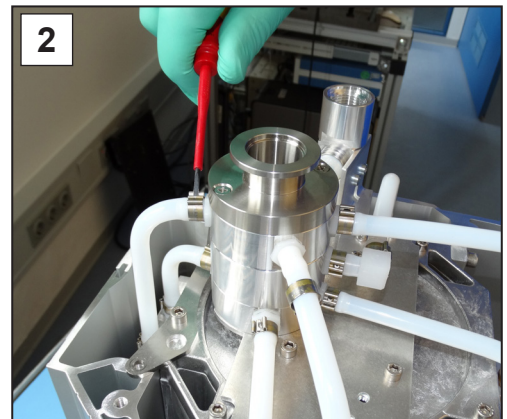

**2.** Only open the hose clips above the pressure distributor; flat-head screwdriver size 1.

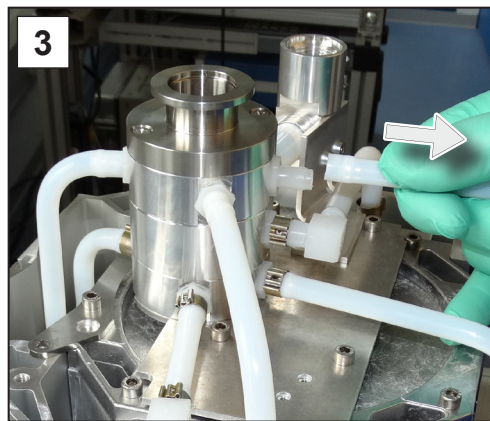

**3.** Remove the molded hoses one by one from the hose nozzles.

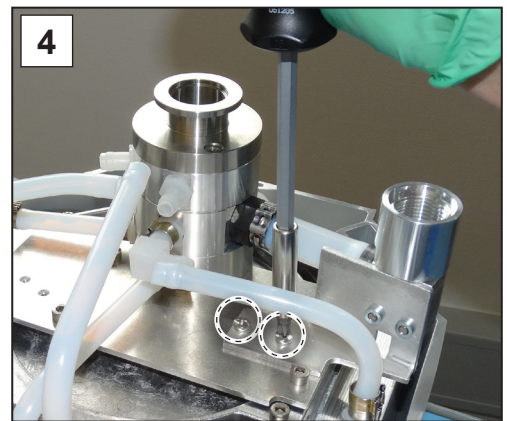

**4.** Unscrew the screws of the outlet holder. Phillips screwdriver size 2.

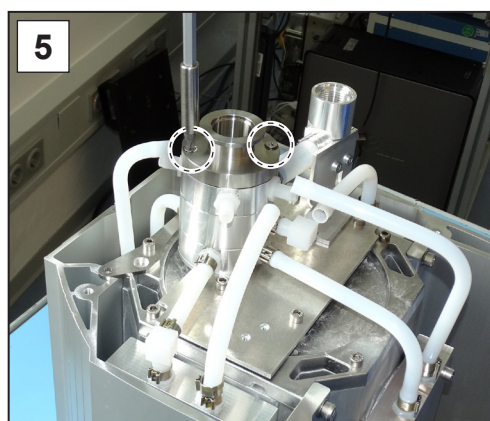

**5.** Unscrew the screws of the distributor. Phillips screwdriver size 2.

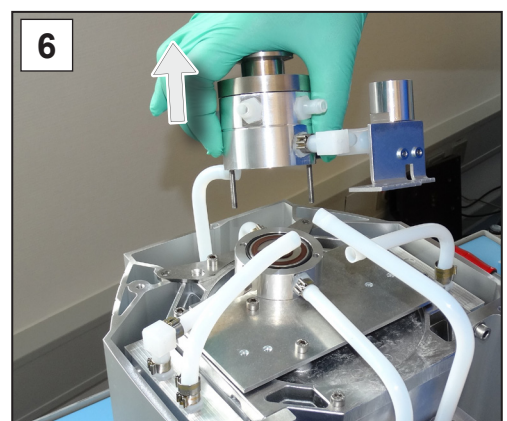

**6.** Remove the suction distributor together with the screws and the outlet holder and put it aside.

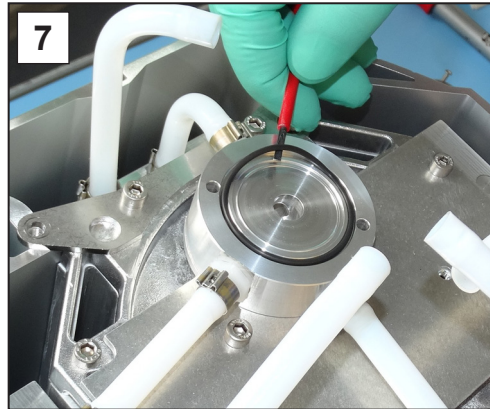

**7.** Carefully remove the used pressure relief valve and the O-ring, e. g., with a narrow flat-head screwdriver.

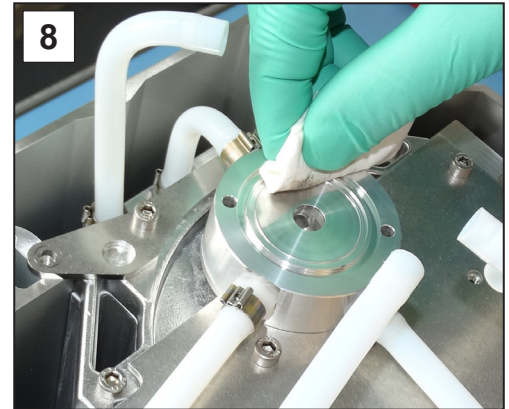

**8.** Clean the pressure distributor if necessary.

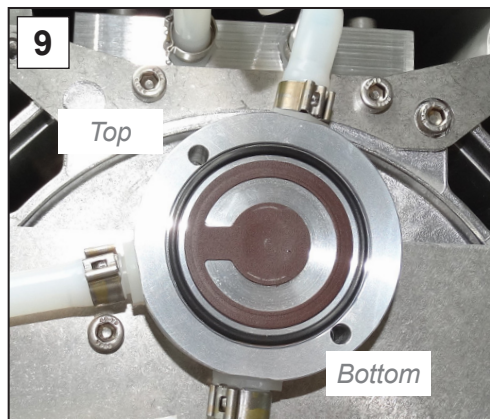

**9.** Place the new pressure relief valve on the clean surface. Ensure the pressure relief valve is positioned correctly on the pressure distributor. Insert the O-ring.

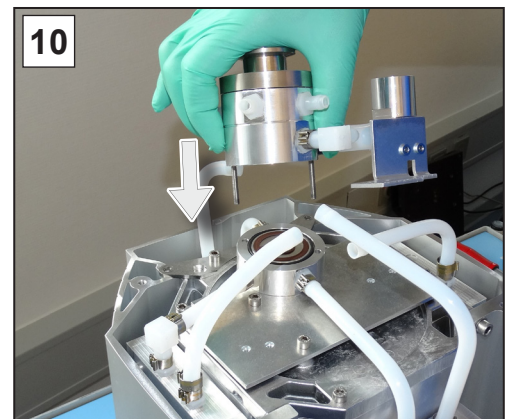

**10.** Place the suction distributor with screws and outlet holder onto the pressure distributor.

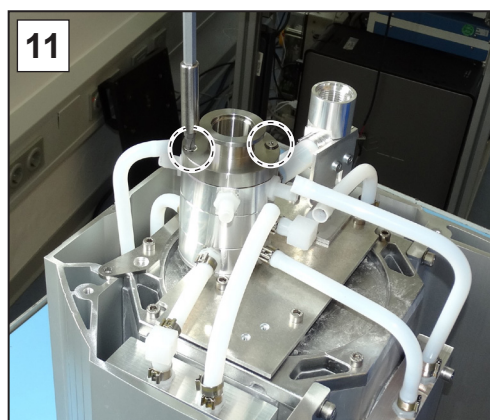

**11.** Wind in the screws at the distributor hand-tight; Phillips screwdriver size 2.



**12.** Wind in the screws at the outlet holder hand-tight; Phillips screwdriver size 2.

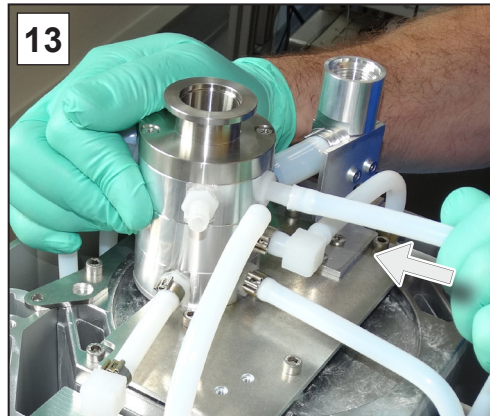

**13.** Push the molded hoses back into place on the hose nozzles.

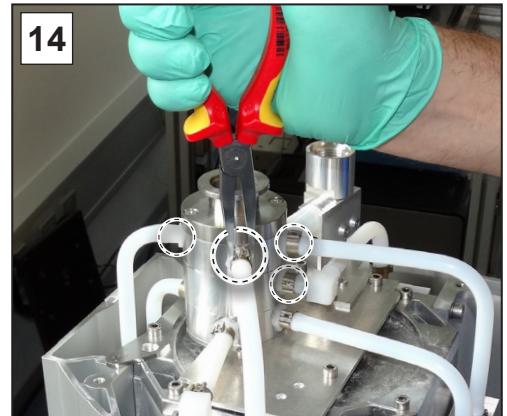

**14.** Secure the hose clips on the hose nozzles, e.g., with flat nose pliers.

### Assemble the device and housing sections

Assemble the device and housing sections



**1.** Insert the bar into the groove between the side panels.

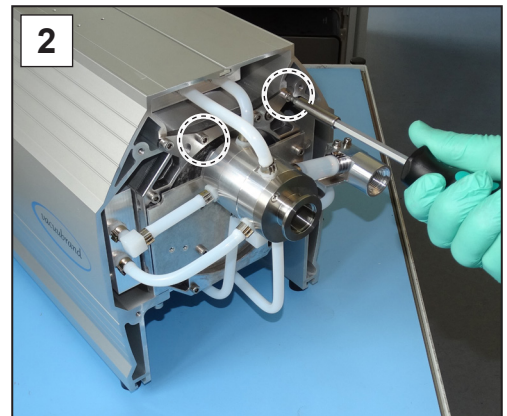

**2.** Wind in the 2 outer screws of the side panel retaining plate at the front; hex key size 4.

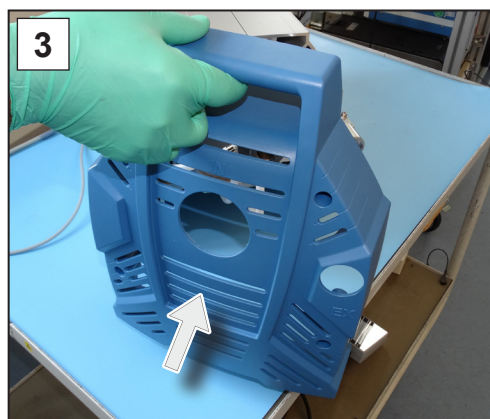

**3.** Place the front housing section.



**4.** Wind in the 4 screws of the front housing section; hex key size 4.

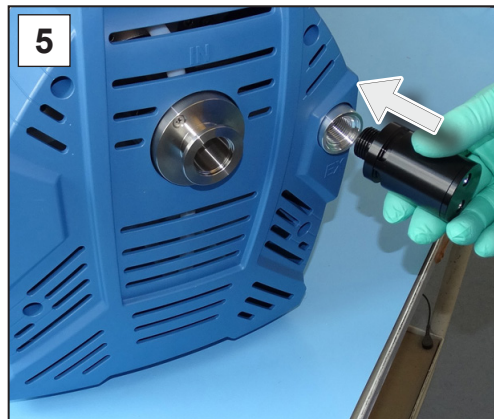

5. Screw the silencer in the thread at the outlet.



6. Secure the controller on the diaphragm pump and connect all cables.



7. Plug in the power plug.

**If maintenance work has been completed in full:**

- ⇒ Connect the hoses for operation.
- ⇒ Connect the diaphragm pump to the power supply.
  - Diaphragm pump is ready to be returned to use.

**If not reconnected:**

- Diaphragm pump is ready for storage.

## 7.4 Replacing the device fuse

At the rear of the pumping unit, at the power supply, there are 2 device fuses, type: 8 AT 5x20.

### Replacing the device fuse

Replacing the device fuse

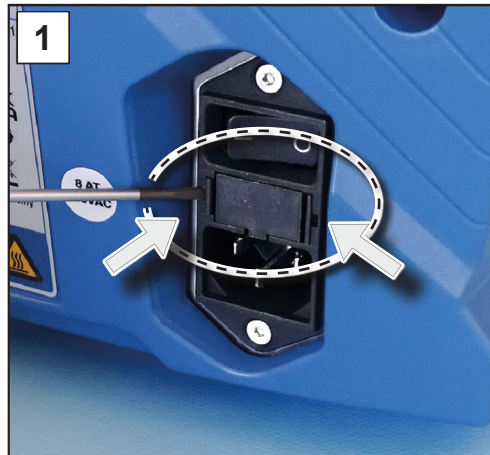

1. First unplug the power connector and then unlock the fuse drawer..



2. Gently pull the securing drawer out of the appliance connector.

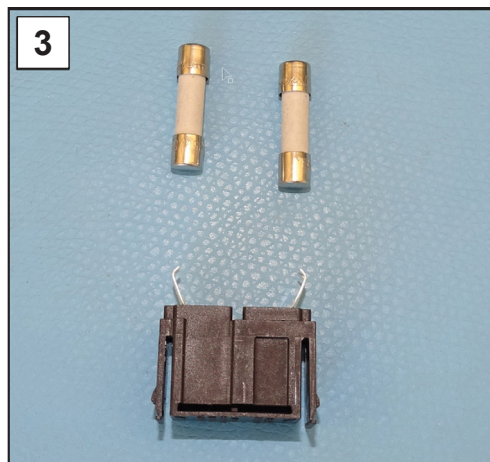

3. Replace defective fuses.



4. Insert the securing drawer into the device connector and press it.

## 8 Appendix

### 8.1 Technical information

<b>Diaphragm pump series</b>	
<b>ME 16 NT VARIO select</b>	<b>MD 12 NT VARIO select</b>
<b>MV 10 NT VARIO select</b>	

#### 8.1.1 Technical data

Technical data

<b>Ambient conditions</b>		(US)
Ambient temperature, max.	10 – 40 °C	50 – 104 °F
Working temperature	10 – 40 °C	50 – 104 °F
Storage/transport temperature	-10 – 60 °C	14 – 140 °F
Max. altitude	2000 m above NHN	6562 ft above sea level
Relative humidity	30 – 85 %, non condensing	
Pollution degree	2	
Protection class	IP 40 / IK 08	

<b>Operating conditions</b>		(US)
<b>Admissible media temperature (gas), non-explosive atmosphere:</b>		
Continuous operation inlet pressure > 100 mbar (75 Torr), high gas load	10 °C – 40 °C	50 – 104 °F
Continuous operation inlet pressure < 100 mbar (75 Torr), low gas load	0 °C – 60 °C	32 – 140 °F
Short-time (< 5 minutes) inlet pressure < 100 mbar (75 Torr), low gas load	-10 °C – 80 °C	14 – 176 °F
ATEX approval if the ATEX marking is shown on the rat- ing plate Inner part (pumped gases)	II 3/- G Ex h IIC T3 Gc X Internal Atm. only Tech.File: VAC-EX02	
<b>Admissible media temperature (gas)  atmosphere:</b>		
Continuous operation inlet pressure > 100 mbar (75 Torr), high gas load	10 °C – 40 °C	50 – 104 °F
Continuous operation inlet pressure < 100 mbar (75 Torr), low gas load	10 °C – 40 °C	50 – 104 °F

## Technical data

Short-time (< 5 minutes) inlet pressure < 100 mbar (75 Torr), low gas load	10 °C – 40 °C	50 – 104 °F
<b>Connections</b>		
Vacuum, inlet	Small flange KF DN 25	
Exhaust gas, outlet EX	Thread 1/2"	
Cold device plug	+ power supply CEE, CH, CN, UK, IN, US	
Plug-in connector	VACUU·BUS®	
<b>Electrical data</b> (US)		
Nominal voltage		
ME 16 NT VARIO select	-	120 V ±10 %
MD 12 NT VARIO select	200 – 230 V ±10 %	100 – 120 V ±10 %
MV 10 NT VARIO select	200 – 230 V ±10 %	100 – 120 V ±10 %
Nominal frequency	50 Hz / 60 Hz	50 Hz / 60 Hz
Overvoltage category	II	
Nominal current, max.	3,5 A	8 A
Power, max.	530 W	0.71 hp
Device fuse	2 slow blow fuses 250 V / 8AT – 5x20	
Motor protection	temperature sensor	
Interface	VACUU·BUS®	
Power cable	2 m	
<b>Vacuum data</b> (US)		
ME 16 NT VARIO select		
Max. pumping speed	19 m <sup>3</sup> /h	11.2 cfm
Ultimate vacuum, abs.	70 mbar	53 Torr
Number of cylinders/stages	8/1	
MD 12 NT VARIO select		
Max. pumping speed	13,4 m <sup>3</sup> /h	7.9 cfm
Ultimate vacuum, abs.	1,5 mbar	1.1 Torr
Number of cylinders/stages	8/3	
MV 10 NT VARIO select		
Max. pumping speed	12,1 m <sup>3</sup> /h	7.1 cfm
Ultimate vacuum, abs.	0,3 mbar	0.2 Torr
Number of cylinders/stages	8/4	
Max. inlet pressure, abs.	1,1 bar	825 Torr
Max. outlet pressure, abs.	1,1 bar	825 Torr
Max. differential pressure, abs.	1,1 bar	825 Torr



## Technical data

<b>Sensor</b>		
Measuring principle	Ceramic diaphragm (aluminum oxide), capacitive, gas type independent, absolute pressure	
Accuracy of measurement	<±1 mbar/hPa/Torr, ±1 digit (after adjustment, constant temperature)	
Upper measurement limit	1080 mbar	810 Torr
Lower measurement limit	0,1 mbar	0.1 Torr
Temperature coefficient	< 0,15 mbar/hPa/K	< 0.11 Torr/K

<b>Weights* and dimensions (l x b x h)</b>		
		(US)
ME 16 NT VARIO select	552 mm x 260 mm x 450 mm	21.7 in x 10.2 in x 17.7 in
Weight*	31,6 kg	69.7 lb
MD 12 NT VARIO select	552 mm x 260 mm x 450 mm	21.7 in x 10.2 in x 17.7 in
Weight*	31,6 kg	69.7 lb
MV 10 VARIO select	552 mm x 260 mm x 450 mm	21.7 in x 10.2 in x 17.7 in
Weight*	31,6 kg	69.7 lb

\* without cable

<b>Other information</b>	
Sensor type	VACUU·SELECT Sensor
Controller	VACUU·SELECT
Emission sound pressure level* (uncertainty $K_{pA}$ : 3 dB(A)) at 1500 rpm/62% (VARIO)	50 dBA

\* Measurement according to DIN EN ISO 2151:2009 and EN ISO 3744:1995 at ultimate vacuum with outlet line at outlet connection

### 8.1.2 Wetted materials

Wetted materials

Component	Wetted materials
<b>Pump</b>	
Housing cover	Aluminium alloy
Head cover	Aluminium alloy (AlSi12)
Diaphragm clamping disc	Aluminium alloy (AlSi12)
Diaphragm	FPM
Valves	FPM
O-rings	FPM
Small flange	Stainless steel
Hose fittings	ETFE/ECTFE
Hoses	PTFE
Inlet	Aluminium alloy
Suction/pressure distributor	Aluminium alloy
Outlet	PTFE carbon reinforced
Silencer	Anodized aluminum / PTFE / PTFE carbon reinforced / spring steel
<b>VACUU-SELECT Sensor</b>	
Vacuum sensor	Aluminum oxide ceramic, gold-coated (if applicable)
Measurement chamber	PPS
Small flange	PP
Sealing ring at the sensor	chemically resistant fluoroelastomer
Hose nozzle	PP

### 8.1.3 Rating plate

Data on rating plate



- ⇒ In the event of an error, make a note of the type and serial number on the rating plate.
- ⇒ When contacting our Service Department, please provide the type and serial number from the rating plate. This will allow us to provide you with specific support and advice for your device.

#### Diaphragm pump rating plate, general

→ Example  
Cut-out showing  
rating plate

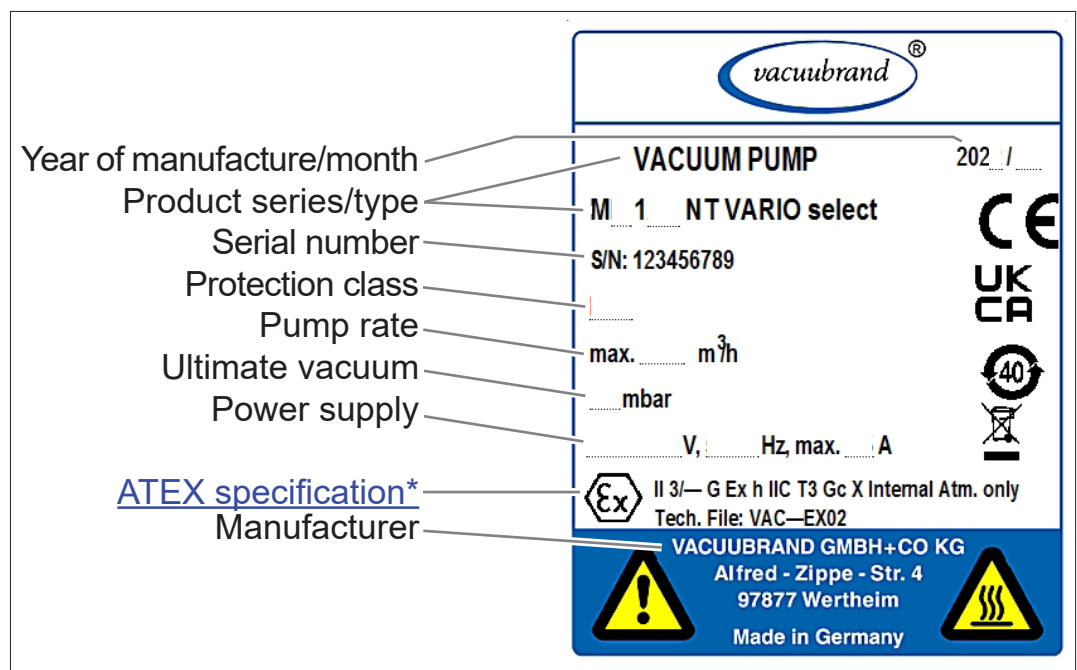

\* Documentation, group and category, marking G (gas), type protection, explosion group, temperature class (additionally see : [Approval for ATEX equipment](#)).

## 8.2 Ordering information

Ordering information  
accessories

<b>Accessories</b>	Order no.
Separator flask AK	20699979
PTFE hose KF DN 25 (l = 1000 mm)	20686033
Hose (rubber) d <sub>i</sub> 15 mm (length to order)	20686003
Stainless steel hose KF DN 25 (l = 1000 mm)	20673337
Coolant valve VKW-B	20674220
Venting valve VBM-B	20674217
Vacuum valve VS 25, KF DN 25	20665005
VACUU·SELECT® Sensor without venting valve	20700021
Vacuum sensor VSK 3000	20640530
Adapter small flange KF DN 25 to hose nozzle DN 15	20662808
Threaded flange KF DN 16 / 1/2"	20672101
Hose nozzle DN 15 mm / 1/2"	20642472
Adapter KF DN 25 to 2x PTFE tube DN 10/8	20667052
Adapter small flange KF DN 16 to hose nozzle 1/2"	20636004
VACUU·BUS Y adapter	20636656
Extension cable VACUU·BUS, 0.5 m	20612875
Extension cable VACUU·BUS, 2 m	20612552
Extension cable VACUU·BUS, 10 m	22618493
VACUU·BUS wall duct	20636153
Calibration (DAkkS accredited) with first delivery	20900214
Recalibration (DAkkS accredited)	20900215
Silencer** G1/2"	20642473

Ordering information  
spare parts

Spare parts		Order no.
Anti-rotation protection D17x17.5		20635113
Service kit MD 12 / MV 10 NT VARIO select		20696827
Service kit ME 16 NT VARIO select		20696819
Power cable	CEE	20612058
	CH	20676021
	CN	20635997
	IND	20635365
	UK	20612065
Silencer** G 1/2"		20642473

**\*\* Caution:** Gases containing dust, deposits and condensed solvent vapors can affect the flow of gas through the silencer. These factors or a high gas flow rate can cause excess pressure to build up, which can damage the pump bearings, diaphragms, and valves. Do not use the silencer in such circumstances.



⇒ A full list of spare parts available can be found under  
→ VACUUBRAND > Support > Repair instructions >  
[Diaphragm pumps](#).

### Sources of supply

Purchase original accessories and original spare parts from a subsidiary of **VACUUBRAND GMBH + CO KG** or your local distributor.

International  
sales offices and  
specialized trade



⇒ Information about our complete product range is available in the current [product catalog](#).  
⇒ Your local distributor or **VACUUBRAND GMBH + CO KG** [sales office](#) is available to assist you with orders, questions on vacuum control and optimal accessories.

## 8.3 Service

Service offer and  
service range

Take advantage of the comprehensive range of services available from **VACUUBRAND GMBH + CO KG**.

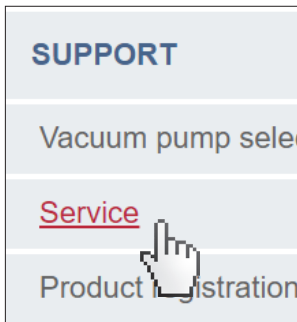

### Services in detail

- Product consultation and practical solutions
- Fast delivery of spare parts and accessories
- Professional maintenance
- Immediate repairs processing
- On-site service (on request)
- [Calibration](#) (DAkkS-accredited)
- With Health and Safety Clearance form: Return, disposal.

⇒ Visit our website for further information: [www.vacuubrand.com](http://www.vacuubrand.com).

### Service handling

Meet the  
terms of service

1. Contact your local distributor or our Service Department.
2. Request an RMA no. for your order.
3. Clean the product thoroughly or if necessary, decontaminate it professionally.
4. Fill out the [Health and Safety Clearance form](#) in full.
5. Return your product, including:
  - RMA no. and description of the error
  - Repair or service order,
  - Health and Safety Clearance form
  - Attach everything to the outside of the package

Return (reshipment)



⇒ Reduce downtime, speed up processing. Please keep the required data and documents ready when contacting our Service Department.

- ▶ Your order can be quickly and easily processed.
- ▶ Hazards can be prevented.
- ▶ A brief description and/or photos will help locate the source of the error.

## 8.4 Index

Index	<b>A</b>	<b>M</b>
	Abbreviations . . . . . 9	Maintain minimum distance . . . . . 19
	Accessories . . . . . 76	Maintain the top, right and left pump head pairs . . . . . 62
	Action steps . . . . . 9	Maintenance . . . . . 47
	Additional symbols . . . . . 8	Maintenance intervals . . . . . 48
	Assemble silencer . . . . . 30	Maintenance of suction/pressure distributor . . . . . 65
	ATEX equipment category . . . . . 21	Mandatory sign . . . . . 8
	ATEX equipment labeling . . . . . 21	Manual structure . . . . . 6
	<b>C</b>	Measurement chamber . . . . . 74
	Clean the surfaces . . . . . 50	Minimum distances . . . . . 27
	Copyright © . . . . . 5	Mount the base (option) . . . . . 28
	<b>D</b>	Mount the side panel . . . . . 63
	Device and housing parts, assemble . . . . . 68	<b>O</b>
	Device and housing parts, disassemble . . . . . 52	Operating elements
	Diaphragm pump stages . . . . . 24	Vacuum controller . . . . . 39
	Disassemble the front housing section . . . . . 52	Operating hours until maintenance 48
	Display conventions . . . . . 7	Operating panel . . . . . 10
	Display of operating steps . . . . . 9	Operator obligations . . . . . 13
	<b>E</b>	Ordering information . . . . . 76
	EC Declaration of Conformity . . . . . 81	Overheating . . . . . 19
	Electrical connection . . . . . 35	Overheating protection . . . . . 20
	Eliminate sources of danger . . . . . 17	<b>P</b>
	Entsorgung . . . . . 22	Peripheral devices and ATEX . . . . . 21
	Error – Cause – Remedy . . . 43, 44, 45	Personnel obligations . . . . . 13
	Exhaust gas connection . . . . . 33	Personnel qualification . . . . . 14
	Explanation of safety symbols . . . . . 8	Power cable . . . . . 35
	Explanation of usage conditions X . 22	Pressure relief valve . . . . . 65
	Exploded-drawing pump head . . . . . 55	Pressure relief valve + O-ring, maintenance . . . . . 65
	Exploded-drawing suction/pressure distributor . . . . . 66	Pressure relief valve + O-ring, replacement . . . . . 66
	<b>F</b>	Prevent blockages in the outlet line 17
	Foreseeable misuse . . . . . 12, 13	Prevent condensate return . . . . . 17
	<b>G</b>	Prevent ignition sources . . . . . 21
	Goods arrival . . . . . 25	Process screen (main screen) . . . . . 38
	<b>H</b>	Product-specific terms . . . . . 10
	Handling instructions . . . . . 9	Prohibition sign . . . . . 8
	Hazards during venting . . . . . 18	Proper disposal . . . . . 22
	Hot surfaces . . . . . 19	Protective clothing . . . . . 15
	<b>I</b>	Pump electrical connection . . . . . 35
	Icons . . . . . 8	<b>Q</b>
	Improper use . . . . . 12	Qualification description . . . . . 14
	Incorrect measurements . . . . . 17	Quality standard . . . . . 15
	Insert valves and O-rings . . . . . 61	<b>R</b>
	Instruction modules . . . . . 6	Rating plate . . . . . 75
	Intended use . . . . . 11	Recommended aids for cleaning and maintenance . . . . . 48
	<b>L</b>	Remove the left side panel . . . . . 53
	Limitation of use . . . . . 27	Remove the right side panel . . . . . 54
		Replacing the device fuse . . . . . 70
		Reset thermal fault . . . . . 45
		Residual energies . . . . . 18
		Responsibility Assignment Matrix . . 14

Index	Responsibility matrix and areas of competence . . . . .	14
	Return (reshipment) . . . . .	78
	Return to use after maintenance . . . . .	69
<b>S</b>		
	Safety information . . . . .	11
	Safety information for vacuum equipment . . . . .	11
	Safety precautions . . . . .	15
	Sales offices . . . . .	77
	Service handling . . . . .	78
	Service range . . . . .	78
	Silencer . . . . .	29
	Silencer at the outlet EX . . . . .	29
	Sources of supply . . . . .	77
	Spare parts . . . . .	77
	Start . . . . .	39
	Stop . . . . .	40
	Storage, prepared . . . . .	69
	Switch pump off . . . . .	41
	Switch pump on . . . . .	37
	Symbols . . . . .	8
<b>T</b>		
	Target groups . . . . .	14
	Technical data . . . . .	71
	Technical information . . . . .	71
	Technical support . . . . .	43
<b>U</b>		
	UKCA Declaration of conformity . . . . .	82
	Unpacking . . . . .	25
	User information . . . . .	5
<b>V</b>		
	VACUU·BUS® . . . . .	10
	VACUU·BUS® connector . . . . .	10
	Vacuum connection . . . . .	31
	Vacuum controller operation . . . . .	38
	Valves, pump head . . . . .	55
	Venting . . . . .	40
<b>W</b>		
	Warning sign . . . . .	8
	Warning signs and labels . . . . .	20
	Wetted materials . . . . .	74



## 8.5 EC Declaration of Conformity

### EG-Konformitätserklärung für Maschinen EC Declaration of Conformity of the Machinery Déclaration CE de conformité des machines



Hersteller / Manufacturer / Fabricant:

VACUUBRAND GMBH + CO KG · Alfred-Zippe-Str. 4 · 97877 Wertheim · Germany

Hiermit erklärt der Hersteller, dass das Gerät konform ist mit den Bestimmungen der Richtlinien:

Hereby the manufacturer declares that the device is in conformity with the directives:

Par la présente, le fabricant déclare, que le dispositif est conforme aux directives:

- 2006/42/EG
- 2014/30/EU
- 2014/34/EU
- 2011/65/EU, 2015/863

Membranvakuumpumpe / Diaphragm vacuum pump / Pompe à membrane:

Typ / Type / Type: **MD 12 NT VARIO select, MV 10 NT VARIO select**

Artikelnummer / Order number / Numéro d'article: **25743150 / 25744150, 25744151, 25744152**

Seriennummer / Serial number / Numéro de série: Siehe Typenschild / See rating plate / Voir plaque signalétique

Angewandte harmonisierte Normen / Harmonized standards applied / Normes harmonisées utilisées:

EN ISO 12100:2010 (ISO 12100:2010), EN 1012-2:1996 + A1:2009, EN 61010-1:2010 + A1:2019 + A1:2019/AC:2019 (IEC 61010-1:2010 + COR:2011 + A1:2016, modifiziert / modified / modifié + A1:2016/COR1:2019)

EN 61326-1:2013 (IEC 61326-1:2012)

EN 1127-1:2019, EN ISO 80079-36:2016 (ISO 80079-36:2016)

EN IEC 63000:2018 (IEC 63000:2016)

Bevollmächtigter für die Zusammenstellung der technischen Unterlagen / Person authorised to compile the technical file / Personne autorisée à constituer le dossier technique:

Dr. Constantin Schöler · VACUUBRAND GMBH + CO KG · Germany

Ort, Datum / place, date / lieu, date: Wertheim, 09.02.2024

(Dr. Constantin Schöler)

*Geschäftsführer / Managing Director / Gérant*

ppa.

(Jens Kaibel)

*Technischer Leiter / Technical Director /  
Directeur technique*

**VACUUBRAND GMBH + CO KG**

Alfred-Zippe-Str. 4  
97877 Wertheim

Tel.: +49 9342 808-0

Fax: +49 9342 808-5555

E-Mail: [info@vacuubrand.com](mailto:info@vacuubrand.com)

Web: [www.vacuubrand.com](http://www.vacuubrand.com)

**VACUUBRAND®**

## 8.6 UKCA Declaration of conformity

### Declaration of Conformity



Manufacturer:

**VACUUBRAND GMBH + CO KG** · Alfred-Zippe-Str. 4 · 97877 Wertheim · Germany

Hereby the manufacturer declares that the device is in conformity with the directives:

- Supply of Machinery (Safety) Regulations 2008  
(S.I. 2008 No. 1597, as amended by S.I. 2019 No. 696)
- Electromagnetic Compatibility Regulations 2016  
(S.I. 2016 No. 1091, as amended by S.I. 2019 No. 696)
- The Equipment and Protective Systems Intended for Use in Potentially Explosive Atmospheres Regulations 2016 (S.I. 2016 No. 1107, as amended by S.I. 2019 No. 696)
- The Restriction of the Use of Certain Hazardous Substances in Electrical and Electronic Equipment Regulations 2012 (S.I. 2012 No. 3032)

Diaphragm vacuum pump:

Type: **MD 12 NT VARIO select, MV 10 NT VARIO select**

Order number: **25743150 / 25744150, 25744151, 25744152**

Serial number: See rating plate

Designated standards applied:

EN ISO 12100:2010, EN 1012-2:1996+A1:2009, EN 61010-1:2010+A1:2019, EN 61010-1:2010/A1:2019/AC:2019-04  
EN 61326-1:2013  
EN 1127-1:2019, EN ISO 80079-36:2016  
EN IEC 63000:2018

Person authorised to compile the technical file:

Dr. Constantin Schöler · VACUUBRAND GMBH + CO KG · Germany

Place, date: Wertheim, 09.02.2024

(Dr. Constantin Schöler)

*Managing Director*

ppa.

(Jens Kaibel)

*Technical Director*

**VACUUBRAND GMBH + CO KG**

Alfred-Zippe-Str. 4  
97877 Wertheim

Tel.: +49 9342 808-0

Fax: +49 9342 808-5555

E-Mail: [info@vacuubrand.com](mailto:info@vacuubrand.com)

Web: [www.vacuubrand.com](http://www.vacuubrand.com)

**VACUUBRAND®**

## 8.7 Declaration of Conformity 符合性声明 – China RoHS 2

VACUUBRAND®

### DECLARATION OF CONFORMITY – China RoHS 2

VACUUBRAND GMBH + CO KG has made reasonable efforts to ensure that hazardous materials and substances may not be used in its products.

In order to determine the concentration of hazardous substances in all homogeneous materials of the subassemblies, a “Product Conformity Assessment” (PCA) procedure was performed. As defined in GB/T 26572 the “Maximum Concentration Value” limits (MCV) apply to these restricted substances:

- Lead (Pb): 0.1%
- Mercury (Hg): 0.1%
- Cadmium (Cd): 0.01%
- Hexavalent chromium (Cr(+VI)): 0.1%
- Polybrominated biphenyls (PBB): 0.1%
- Polybrominated diphenyl ether (PBDE): 0.1%

### Environmentally Friendly Use Period (EFUP)

EFUP defines the period in years during which the hazardous substances contained in electrical and electronic products will not leak or mutate under normal operating conditions. During normal use by the user such electrical and electronic products will not result in serious environmental pollution, cause serious bodily injury or damage to the user’s assets. The Environmentally Friendly Use Period for VACUUBRAND products is 40 years.



MATERIAL CONTENT DECLARATION FOR VACUUBRAND PRODUCTS						
有毒有害物质或元素 Hazardous substances						
部件名称 Part name	铅 Pb	汞 Hg	镉 Cd	六价铬 Cr(+VI)	多溴联苯 PBB	多溴二苯醚 PBDE
包装 Packaging	0	0	0	0	0	0
塑料外壳 / 组件 Plastic housing / parts	0	0	0	0	0	0
真空油 Vacuum oil	0	0	0	0	0	0
电池 Battery	0	0	0	0	0	0
玻璃 Glass	X	0	0	0	0	0
电子电气组件 Electrical and electronic parts	X	0	0	0	0	0
控制器 / 测量设备 Controller / measuring device	X	0	0	0	0	0
金属外壳 / 组件 Metal housing / parts	X	0	0	0	0	0
电机 Motor	X	0	0	0	0	0
配件 Accessories	X	0	0	0	0	0

此表格是按照SJ/T 11364-2014中规定所制定的。  
This table is created according to SJ/T 11364-2014.

## VACUUBRAND®

- O: 表示该有毒有害物质在该部件所有均质材料中的含量均在GB/T 26572规定的限量要求以下。  
 O: Indicates that the above mentioned hazardous substance contained in all homogeneous materials of the part is below the required limit as defined in GB/T 26572.
- X: 表示该有毒有害物质至少在该部件某一均质材料中的含量超出GB/T 26572规定的限量要求。  
 X: Indicates that the above mentioned hazardous substance contained in at least one of the homogeneous materials of this part is above the required limit as defined in GB/T 26572.

电池、玻璃器皿和配件可能不属于所附设备所包含的内容，它们可能有各自单独的EFUP标记和/或可能正在维护其部件EFUP标记的更新。

Batteries, glassware and accessories might not be content of the enclosed device and may have its own EFUP-marking and/or might be maintaining parts with changing EFUP-marking.

除上表所示信息外，还需声明的是，这些部件并非是有意图用铅（Pb）、汞（Hg）、镉（Cd）、六价铬（Cr(+VI)）、多溴联苯（PBB）或多溴二苯醚（PBDE）来制造的。

Apart from the disclosures in the above table, the subassemblies are not intentionally manufactured or formulated with lead (Pb), mercury (Hg), cadmium (Cd), hexavalent chromium (Cr+VI), polybrominated biphenyls (PBB), and polybrominated diphenyl ethers (PBDE).

Products manufactured by VACUUBRAND may enter into further devices (e.g., rotary evaporator) or can be used together with other appliances (e.g., usage as booster pumps).

With these products and appliances in particular, please note the EFUP labeled on these products.

VACUUBRAND will not take responsibility for the EFUP of those products and appliances.

Place, date: Wertheim, 06 September 2022



(Dr. Constantin Schöler)  
 Managing Director



ppa. (Jens Kaibel)  
 Technical Director

## VACUUBRAND GMBH + CO KG

Alfred-Zippe-Str. 4  
 97877 Wertheim  
 Germany

Tel.: +49 9342 808-0  
 Fax: +49 9342 808-5555  
 E-Mail: info@vacuubrand.com  
 Web: www.vacuubrand.com







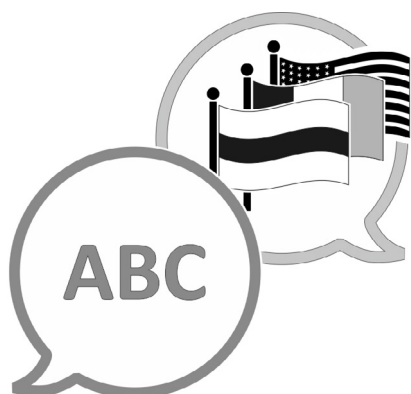
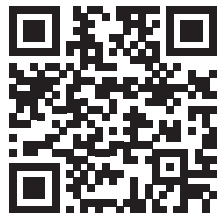

[VACUUBRAND > Support > Manuals](#)

Manufacturer:

**VACUUBRAND GMBH + CO KG**  
**Alfred-Zippe-Str. 4**  
**97877 Wertheim**  
**GERMANY**

Phone:

Head office +49 9342 808-0  
Sales +49 9342 808-5550  
Service +49 9342 808-5660

Fax: +49 9342 808-5555

Email: [info@vacuubrand.com](mailto:info@vacuubrand.com)

Web: [www.vacuubrand.com](http://www.vacuubrand.com)