



Technology for Vacuum Systems

Instructions for use

Part I of II



Part I:
Safety information -
Technical data -
Use and operation

PC 3001 VARIO^{pro}
PC 3001 VARIO^{pro} TE
PC 3001 VARIO^{pro} IK
PC 3001 VARIO^{pro} EK Peltronic

Chemistry pumping unit with speed control



Dear customer,

Your VACUUBRAND diaphragm pumps are designed to provide you with many years of trouble-free service with optimal performance. Our many years of practical experience allow us to provide a wealth of application and safety information. Please read these instructions for use before the initial operation of your pump.

VACUUBRAND diaphragm pumps combine our many years of experience in design, construction and practical operation, with the latest developments in material and manufacturing technology.

Our quality maxim is the "zero defect" principle:

Every diaphragm pump, before leaving our factory, is tested intensively, including an endurance run of 14 hours. Any faults, even those which occur rarely, are identified and can be eliminated immediately.

After completion of the endurance run, every pump is tested, and must achieve specifications before shipment.

We are committed to providing our customers only pumps that meet this high quality standard.

While our pumps cannot eliminate all of your work, we design, manufacture and test them to ensure that they will be an effective and trouble-free tool to assist you in that work.

Yours,

VACUUBRAND GMBH + CO KG

After sales service:

Contact your local dealer or call +49 9342 808-5500.

Trademark index:

VACUU·LAN® (US-Reg.No 3,704,401), VACUU·BUS®, VACUU·CONTROL®, VACUU·SELECT® (US-Reg.No 5,522,260), VARIO® (US-Reg.No 3,833,788), VACUUBRAND® (US-Reg.No 3,733,388), VACUU·VIEW®, GREEN VAC® (US-Reg.No. 4,924,553), VACUU·PURE® (US-Reg.No. 5,559,614) and also the shown company logos are registered trademarks of VACUUBRAND GMBH + CO KG in Germany and/or other countries.

DE

Achtung: Die vorliegende Betriebsanleitung ist nicht in allen EU-Sprachen verfügbar. Der Anwender darf die beschriebenen Geräte nur dann in Betrieb nehmen, wenn er die vorliegende Anleitung versteht oder eine fachlich korrekte Übersetzung der vollständigen Anleitung vorliegen hat. Die Betriebsanleitung muss vor Inbetriebnahme der Geräte vollständig gelesen und verstanden werden, und alle geforderten Maßnahmen müssen eingehalten werden.  "Sicherheitshinweise für Vakuumgeräte"

EN

Attention: This manual is not available in all languages of the EU. The user must not operate the device if he does not understand this manual. In this case a technically correct translation of the complete manual has to be available. The manual must be completely read and understood before operation of the device and all required measures must be applied.  "Safety instructions for vacuum equipment"

FR

Attention: Le mode d'emploi présent n'est pas disponible dans toutes les langues d'Union Européenne. L'utilisateur ne doit mettre le dispositif en marche que s'il comprend le mode d'emploi présent ou si une traduction complète et correcte du mode d'emploi est sous ses yeux. Le dispositif ne doit pas être mis en marche avant que le mode d'emploi ait été lu et compris complètement et seulement si le mode d'emploi est observé et tous les mesures demandées sont prises.

 «Avis de sécurité pour des dispositifs à vide»

BG

Внимание: Тези инструкции не са преведени на всички езици от ЕО. Потребителят не бива да работи с уреда, ако не разбира инструкциите за ползване. В този случай е необходимо да бъде предоставен пълен технически превод на инструкциите за ползване. Преди работа с уреда е задължително потребителят да прочете изцяло инструкциите за работа.

 "Указания за безопасност за вакуумни уреди"

CN

注意：该操作手册不提供所有的语言版本。操作者在没有理解手册之前，不能操作该设备。在这种情况下，需要有一个整个操作手册技术上正确的翻译。在操作该设备前，必须完全阅读并理解该操作手册，必须实施所有需要的测量。

 真空设备的安全信息

CZ

Upozornění :Tento návod k použití není k dispozici ve všech jazycích Evropské unie. Uživatel není oprávněn požit přístroj pokud nerozumí tomuto návodu. V takovém případě je nutno zajistit technicky korektní překlad manuálu do češtiny. Návod musí být uživatelem prostudován a uživatel mu musí plně porozumět před tím než začne přístroj používat. Uživatel musí dodržet všechna příslušná a požadovaná opatření.  "Bezpečnostní upozornění pro vakuové přístroje".

DA

Bemærk: Denne manual foreligger ikke på alle EU sprog. Brugeren må ikke betjene apparatet hvis manualen ikke er forstået. I det tilfælde skal en teknisk korrekt oversættelse af hele manual stilles til rådighed. Manual skal være gennemlæst og forstået før apparatet betjenes og alle nødvendige forholdsregler skal tages.

 »Sikkerhedsregler for vakuumdstyr«

EE

Tähelepanu! Käesolev kasutusjuhend ei ole kõigis EL keeltes saadaval. Kasutaja ei tohi seadet käsitseda, kui ta ei saa kasutusjuhendist aru. Sel juhul peab saadaval olema kogu kasutusjuhendi tehniliselt korrektne tõlge. Enne seadme kasutamist tuleb kogu juhend läbi lugeda, see peab olema arusaadav ning kõik nõutud meetmed peavad olema rakendatud.  "Ohutusnõuded vaakumseadmetele"

ES

Atención: Este manual no está disponible en todos los idiomas de UE. El usuario no debe manejar el instrumento si no entiende este manual. En este caso se debe disponer de una traducción técnicamente correcta del manual completo. El manual debe ser leído y entendido completamente y deben aplicarse todas las medidas de seguridad antes de manejar el instrumento.  "Notas sobre la seguridad para equipos de vacío"

FI

Huomio: Tämä käyttöohje ei ole saatavilla kaikilla EU: n kielillä. Käyttäjä ei saa käyttää laitetta, jos hän ei ymmärrä tätä ohjekirjaa. Tässä tapauksessa on saatavilla oltava teknisesti oikein tehty ja täydellinen ohjekirjan käännös. Ennen laitteen käyttöä on ohjekirja luettava ja ymmärrettävä kokonaan sekä suoritettava kaikki tarvittavat valmistelut ja muut toimenpiteet.  "Vakuumlaitteen turvallisuustiedot"

GR

Προσοχή! : Οι οδηγίες αυτές δεν είναι διαθέσιμες σε όλες τις γλώσσες της Ευρωπαϊκής Ένωσης. Ο χρήστης δεν πρέπει να θέσει σε λειτουργία την συσκευή αν δεν κατανοήσει πλήρως τις οδηγίες αυτές. Σε τέτοια περίπτωση ο χρήστης πρέπει να προμηθευτεί ακριβή μετάφραση του βιβλίου οδηγιών. Ο χρήστης πρέπει να διαβάσει και να κατανοήσει πλήρως τις οδηγίες χρήσης και να λάβει όλα τα απαραίτητα μέτρα πριν θέσει σε λειτουργία την συσκευή.  "Υποδείξεις ασφάλειας για αντλίες κενού"

HR

Pažnja: ove upute ne postoje na svim jezicima Europske Unije. Korisnik nemora raditi sa aparatom ako ne razumije ove upute. U tom slučaju tehnicki ispravni prijevod cijelih uputstava mora biti na raspolaganju. Uputstva moraju biti cijela procitana i razumljiva prije rada sa aparatom i sve zahtijevane mjere moraju biti primjenjene.

 "Sigurnosne napomene za vakuumske uređaje"

HU

Figyelem! Ez a kezelési utasítás nem áll rendelkezésre az EU összes nyelvén. Ha a felhasználó nem érti jelen használati utasítás szövegét, nem üzemeltetheti a készüléket. Ez esetben a teljes gépkönyv fordításáról gondoskodni kell. Üzembe helyezés előtt a kezelőnek végig kell olvasnia, meg kell értenie azt, továbbá az üzemeltetéshez szükséges összes mérést el kell végeznie.  "A vákuum-készülékekkel kapcsolatos biztonsági tudnivalók"

IT

Attenzione: Questo manuale non è disponibile in tutte le lingue della Comunità Europea (CE). L'utilizzatore non deve operare con lo strumento se non comprende questo manuale. In questo caso deve essere resa disponibile una traduzione tecnicamente corretta del manuale completo. Il manuale deve essere completamente letto e compreso prima di operare con lo strumento e devono essere applicati tutti gli accorgimenti richiesti.  "Istruzioni di sicurezza per apparecchi a vuoto"

JP

注意：この取扱説明書はすべての言語で利用可能ではありません。もしこの取扱説明書を理解できないならば、ユーザーは装置を操作してはなりません。この場合、技術的に正しい翻訳がなされた完全なマニュアルを用意しなければなりません。装置を作動する前にマニュアルを完全に読み、そして理解されなくてはなりません。そして、すべての要求される対策を講じなければなりません。

 真空装置を安全に取り扱うために

KR

주의: 이 매뉴얼은 모든 언어로 번역되지 않습니다. 만약 이 매뉴얼의 내용을 충분히 인지하지 못했다면 기기를 작동하지 마십시오. 매뉴얼의 내용을 기술적으로 정확하게 번역한 경우에 이용하십시오. 기기를 사용하기 전에 이 매뉴얼을 충분히 읽고 이해하고 모든 요구되는 사항들을 적용해야 합니다.

 진공 장비에 대한 안전 정보

LT

Dėmesio: šis vadovas nėra pateikiamas visomis ES kalbomis. Naudotojui draudžiama eksploatuoti įtaisą, jeigu jis nesupranta šio vadovo. Tokiu atveju reikia turėti viso vadovo techniškai taisyklingą vertimą. Vadovą būtina visą perskaityti ir suprasti pateikiamas instrukcijas prieš pradėdant eksploatuoti įtaisą, bei imtis visų reikiamų priemonių.  "Vakuuminės įrangos saugos informacija"

LV

Uzmanību: Lietotāja instrukcija nav pieejama visās ES valodās. Lietotājs nedrīkst lietot iekārtu, ja viņš nesaprot lietotāja instrukcijā rakstīto. Šādā gadījumā, ir nepieciešams nodrošināt tehniski pareizu visas lietotāja instrukcijas tulkojumu. Pirms sākt lietot iekārtu, un, lai izpildītu visas nepieciešamās prasības, iekārtas lietotāja instrukcija ir pilnībā jāizlasa un jāsaprot.  "Vakuuma iekārtu drošības noteikumi"

NL

Attentie: Deze gebruiksaanwijzing is niet in alle talen van de EU verkrijgbaar. De gebruiker moet niet met dit apparaat gaan werken als voor hem/haar de gebruiksaanwijzing niet voldoende duidelijk is. Bij gebruik van deze apparatuur is het noodzakelijk een technisch correcte vertaling van de complete gebruiksaanwijzing te hebben. Voor het in gebruik nemen van het apparaat moet de gebruiksaanwijzing volledig gelezen en duidelijk zijn en dienen alle benodigde maatregelen te zijn genomen.  "Veiligheidsvoorschriften voor vacuümapparaten"

PL

Uwaga!! Ta instrukcja nie jest dostępna we wszystkich językach Unii Europejskiej. Użytkownik nie może rozpocząć pracy z urządzeniem dopóki nie przeczytał instrukcji i nie jest pewien wszystkich informacji w niej zawartych. Instrukcja musi być w całości przeczytana i zrozumiana przed podjęciem pracy z urządzeniem oraz należy podjąć wszystkie niezbędne kroki związane z prawidłowym użytkowaniem.

 "Wskazówki bezpieczeństwa do urządzeń próżniowych"

PT

Atenção: Este manual não está disponível em todas as línguas da UE. O usuário não deve utilizar o dispositivo, se não entender este manual. Neste caso, uma tradução tecnicamente correta do manual completo tem de estar disponível. O manual deve ser lido e entendido completamente antes da utilização do equipamento e todas as medidas necessárias devem ser aplicadas.  "Informação de Segurança para Equipamento que funciona a Vácuo"

RO

Atentie: Acest manual nu este disponibil in toate limbile EU. Utilizatorul nu trebuie sa lucreze cu aparatul daca nu intelege manualul. Astfel, va fi disponibile o traducere corecta si completa a manualului. Manualul trebuie citit si inteles in intregime inainte de a lucra cu aparatul si a luat toate masurile care se impun.

 "Instrucțiuni de siguranță pentru aparatele de vidare"

RU

Внимание: Эта инструкция по эксплуатации не имеется на всех языках. Потребителю не дозволено эксплуатировать данный прибор, если он не понимает эту инструкцию. В этом случае нужен технически правильный перевод полной инструкции. Прежде чем использовать этот прибор, необходимо полностью прочитать и понять эту инструкцию и принять все необходимые меры.  "Указания по технике безопасности при работе с вакуумными устройствами"

SE

Varning: Denna instruktion är inte tillgänglig på alla språk inom EU. Användaren får inte starta utrustningen om hon/han inte förstår denna instruktion. Om så är fallet måste en tekniskt korrekt instruktion göras tillgänglig. Instruktionen måste läsas och förstås helt före utrustningen tas i drift och nödvändiga åtgärder göres.

 "Säkerhetsinformation för vakuumutrustning"

SI

Pozor: Ta navodila niso na voljo v vseh jezikih EU. Uporabnik ne sme upravljati z napravo, če ne razume teh navodil. V primeru nerazumljivosti mora biti na voljo tehnično pravilen prevod. Navodila se morajo prebrati in razumeti pred uporaba naprave, opravljene pa moraja biti tudi vse potrebne meritve.

 "Varnostni nasveti za vakuumske naprave"

SK

Upozornenie: Tento manuál nie je k dispozícii vo všetkých jazykoch EÚ. Užívateľ nesmie obsluhovať zariadenie, pokiaľ nerozumie tomuto manuálu. V takomto prípade musí byť k dispozícii technicky správny preklad celého manuálu. Pred obsluhou zariadenia je potrebné si prečítať celý manuál a porozumieť mu, a musia byť prijaté všetky opatrenia.  "Bezpečnostné pokyny pre vákuové zariadenia"

TR

Dikkat : Bu kullanım kitabı, tüm dillerde mevcut değildir. Kullanıcı, bu kullanım kitabını anlayamadıysa cihazı çalıştırmamalıdır. Bu durumda, komple kullanım kitabının, teknik olarak düzgün çevirisinin bulunması gerekir. Cihazın çalıştırılmasından önce kullanım kitabının komple okunması ve anlaşılması ve tüm gerekli ölçümlerin uygulanması gerekir.  "Vakumlu cihazlar için güvenlik uyarıları"

Reset / Language selection

1 switch off



2 press both ↓ ↓

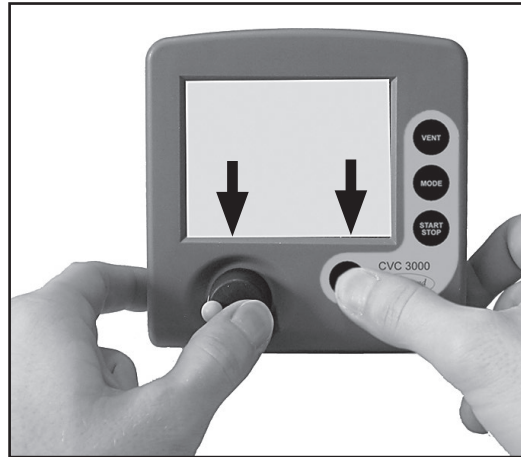

3 turn ↺ ↻



4 press ↓

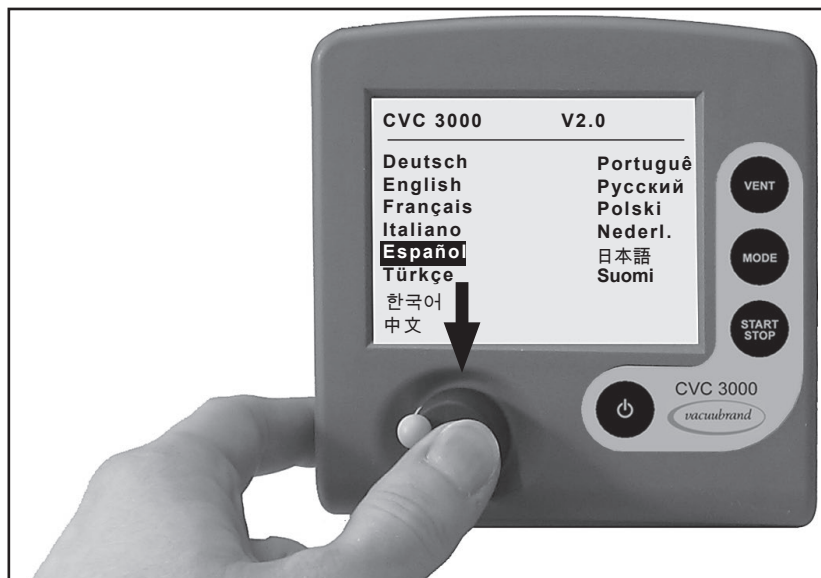

Contents

Part I	1
Reset / Language selection	8
Safety information!	11
Important information!	11
General information	13
Intended use.....	13
Setting up and installing the equipment	14
Ambient conditions	17
Operating conditions	17
Safety during operation	19
Maintenance and repair.....	23
⊠ Important information: Equipment marking (ATEX).....	25
Technical data	27
General technical data valid for all pumping units.....	27
Gas inlet temperatures	31
Wetted parts	31
Abbreviations.....	32
Pump parts	32
Use and operation	39
Installing a pump in a vacuum system	39
Notes regarding the (dry) ice condenser	44
Notes concerning the operation of the inlet condenser IK	46
Notes concerning the operation of the Peltronic emission condenser	47
Notes concerning the operation of pumping units with silencer	47
During operation.....	48
Important notes regarding the use of gas ballast	49
Important notes concerning the operation of the exhaust waste vapor condenser.....	50
Shutdown & storage.....	52
CVC 3000 Vacuum controller	53
Menu guide	58
Pump down function	60
Vac Control function	62
Auto mode	65
Program function	67
Application example	69

VACUULAN function	70
Application examples	72
Vacuum for filtration and suction	72
Vacuum for gel dryer, drying chambers and vacuum concentrators	73
Vacuum for distillation and evaporation (e.g., rotary evaporator)	73
Vacuum for VACUU•LAN networks	75
Configuration	76
Part II	81
Readjustment of CVC 3000	84
Calibration in the factory	86
Cleaning the pressure transducer	87
Interface parameters	88
Setting of the interface	89
Read commands "CVC 2000"	90
Write commands "CVC 2000"	91
Read commands "CVC 3000"	93
Write commands "CVC 3000"	95
Accessories	98
Troubleshooting	99
Replacing diaphragms and valves	103
Cleaning and inspecting the pump heads	105
Disassembling the housing cover at the side of the emission condenser.....	107
Replacing the diaphragm	109
Assembling the housing cover at the side of the emission condenser.....	112
Disassembling the housing cover at the side of the ON/OFF switch	112
Assembling the housing cover at the side of the ON/OFF switch	113
Assembling the fittings.....	113
Cleaning and replacing components	116
Repair - Maintenance - Return - Calibration	117
Warranty	119
Declarations and certificates	121
China RoHS	124

Safety information!

Important information!

WARNING

- ☞ Keep this manual complete and accessible to personnel at all times!
- ☞ Read this manual carefully before installing or operating the equipment. Observe the instructions contained in this manual.
PC 3001 VARIO^{pro} with Peltronic emission condenser: Read the manual of the emission condenser Peltronic as well and observe likewise the instructions contained in that manual.
- ☞ Do not modify the equipment without authorization.

NOTICE

This manual is an integral part of the equipment described therein. It describes the safe and proper use of the vacuum pump. The manual consists of two parts. Make operating personnel aware of dangers arising from the pump and the pumped substances. **VACUUBRAND disclaims any liability for inappropriate use of these pumps and for damage from failure to follow instructions contained in this manual.**

This manual is only to be used and distributed in its complete and original form. It is strictly the users' responsibility to check carefully the validity of this manual with respect to his product.

Manual-no.: 20901092 / 20901093

The following signal word panels and safety symbols are used throughout this manual:



This is the safety alert symbol. It is used to alert you to potential personal injury hazards. Obey all safety messages that follow this symbol to avoid possible injury and death.



➔ DANGER indicates a hazardous situation which, if not avoided, will result in death or serious injury.



☞ WARNING indicates a hazardous situation which, if not avoided, could result in death or serious injury.



• CAUTION indicates a hazardous situation which, if not avoided, could result in minor or moderate injury.



NOTICE is used to address practices not related to personal injury.



Caution! Hot surface!



Disconnect equipment from AC power.



Electronic components must not be disposed of in the domestic waste at the end of their service life. Used electronic devices contain harmful substances that can cause damage to the environment or human health. End users are legally obliged to take used electric and electronic devices to a licensed collection point.



This product has been tested to the requirements of CAN/CSA-C22.2 No. 61010-1, second edition, including amendment 1, or a later version of the same standard incorporating the same level of testing requirements.

Formatting used in this manual:

Note: The signal word panels in all sections of this manual always refer to all paragraphs of the same format (➔ / ☞ / • / plain text) following each signal word panel.

The document "Safety information for vacuum equipment" is part of this manual! Read the "Safety information for vacuum equipment" and observe the instructions contained therein!

General information

NOTICE

Remove all packing material from the packing box. Remove the product from its packing box and retain all packaging until the equipment is inspected and tested. Remove the protective caps from the inlet and outlet ports and retain for future use. Inspect the equipment promptly and carefully.

If the equipment is damaged, notify the supplier and the carrier in writing within three days. Retain all packing material for inspection. State the item number of the product together with the order number and the supplier's invoice number. Failure to check and give notice of damage will void any and all warranty claims for those deficiencies.

Replace the protective caps if the equipment is not used immediately. Store the equipment in dry and non-corrosive conditions (see also „Technical data“, pg. 27).

WARNING

☞ **Do not use any damaged equipment.**

CAUTION

- Use the mounted handle when moving the pumping unit.

Intended use

WARNING

☞ Do not use the pump or any system parts on humans or animals.

☞ Ensure that the individual components are only connected, combined and operated according to their design and as indicated in the instructions for use. Use only **original manufacturer's spare parts and accessories**. Otherwise the safety and performance of the equipment, as well as the electromagnetic compatibility of the equipment might be reduced.

The CE mark or the cTÜVus mark may be voided if not using original manufacturer's spare parts.

- ☞ Comply with all notes on correct vacuum and electrical connections; see section „Use and operation“, pg. 39.
- ☞ Do not use the pump to generate pressure.
- ☞ The pumps are designed for **ambient temperatures** during operation between +50°F and +104°F (+10°C and +40°C). Periodically check maximum temperatures if installing the pump in a cabinet or a housing. Make sure ventilation is adequate to maintain recommended operating temperature. Install an external automatic ventilation system if necessary. If pumping hot process gases, make sure that the maximum permitted gas inlet temperature is not exceeded. The maximum permitted gas inlet temperature depends on several parameters like inlet pressure and ambient temperature (see „Technical data“, pg. 27).
- ☞ Particles and dust must not enter the pump.
- ☞ Do not pump liquids.

CAUTION

- Ensure that the pump, and any accessories in the flow path are chemically resistant to the pumped substances prior to operation.

NOTICE

Use the equipment **only as intended**, that is, for generation, measurement, and control of vacuum in vessels designed for that purpose. Any other use will automatically invalidate all warranty and liability claims. Remain aware of safety and risks.

Setting up and installing the equipment

DANGER

- ➔ Equipment must be connected only to a **suitable electrical supply** and a suitable ground point. As such, the plug must be plugged into an outlet that is properly grounded. Failure to connect the motor to ground may result in deadly electrical shock.

The supply cable may be fitted with a molded European IEC plug or a plug suitable for your local electrical supply. The cable contains wires color coded as follows: green or green and yellow: ground; blue or white: neutral; brown or black: hot.

WARNING

- ☞ Due to the high compression ratio, the pump may generate overpressure at the outlet. Check pressure compatibility with system components (e.g., exhaust pipeline or exhaust valve) at the outlet.
- ☞ Do not permit any **uncontrolled pressurizing**. Make sure that the exhaust pipeline cannot become blocked. If there is an exhaust isolation valve, make sure that you cannot operate the equipment with the valve closed to avoid a **risk of bursting!**
- ☞ Maximum permissible pressure at the pressure transducer: 21.8 psi (1.5 bar) absolute.
- ☞ Keep the electrical power cord away from heated surfaces.
- ☞ Keep the electrical power cord away from hot surfaces.

CAUTION

- Provide a firm, level platform for the equipment. Check that the system which you are going to evacuate is mechanically stable. Check that all fittings are secure. Ensure a stable position of the pump without any mechanical contact other than the pump feet.
- Comply with **maximum permissible pressures** at inlet and outlet and with **maximum permissible pressure differences** between inlet and outlet. See section „Technical data“, pg. 27. Do not operate the pump with overpressure at the inlet.
- Avoid overpressure of more than 17.5 psi absolute (1.2 bar absolute) in the event that inert gas is connected to the pump, to the gas ballast or to a venting valve.
- **Note:** Flexible elements will shrink when evacuated.
- Connect hoses gas tight at inlet and outlet of the pump.

- Ensure that no foreign objects can be drawn into the pump.
- Check the power source and the pump's rating plate to be sure that the power source and the equipment match in voltage, phase, and frequency.
- Ensure that the **coolant outlet pipe** is always free and that it cannot get blocked. If installing an optional coolant valve, it must always be in the supply line of the exhaust waste vapor condenser.

NOTICE

Make sure ventilation is adequate to maintain recommended operating temperature. Keep a minimum distance of 2 in (5 cm) between the cooling fan and surrounding items (e.g., housing, walls, etc.), or else install an external automatic ventilation system. Clean ventilation slots if necessary to avoid a reduction of ventilation.

Do not place the pumping unit on soft surfaces (e.g., rubber foam) during operation. This may reduce or block the electronics' air supply. Do not cover the pumping unit.

The mains plug is a disconnecting device to separate the pump from the supply voltage. Ensure that the mains plug is easily accessible at all times to allow the separation of the device from the power supply.

Use only hoses at the inlet and outlet of the pump with an inner diameter at least as large as the diameter of the pump's tubing (to avoid overpressure at the outlet, and reduction of pumping speed at the inlet).

Allow the equipment to equilibrate to ambient temperature if you bring it from cold environment into a room prior to operation. Notice if there is water condensation on cold surfaces.

Secure coolant hoses at the hose nozzles (e.g., with hose clamp) to prevent their accidental slipping.

Comply with all **applicable and relevant safety requirements** (regulations and guidelines). **Implement the required actions and adopt suitable safety measures.**

Ambient conditions

DANGER

- ➔ Do not reach for this product if it has fallen into liquid. There is a risk of deadly electrical shock. Unplug the system immediately.

WARNING

- ☞ Do not use this product in an area where it can fall or be pulled into water or other liquids.

CAUTION

- This product may only be used indoors in a non-explosive atmosphere, and in a dry environment. Adopt suitable measures in case of differences from recommended conditions, e.g., installation in higher altitudes (risk of insufficient cooling), conductive pollution or external condensation on the pump.
- Do not operate this product near flames.

NOTICE

To the best of our knowledge the equipment is in compliance with the requirements of the applicable EC-directives and harmonized standards (see "Declaration of Conformity") with regard to design, type and model. Directive EN 61010-1 gives in detail the conditions under which the equipment can be operated safely (see also IP degree of protection, „Technical data“, pg. 27).

Operating conditions

DANGER

- ➔ These pumps are not approved for operation in potentially explosive atmospheres. **Do not operate the pumps in potentially explosive atmospheres.**

- ➔ Pumps **without the „ Ex ” mark on the rating plate are not approved for the pumping of potentially explosive atmospheres. Do not pump potentially explosive atmospheres with those pumps.**
- ➔ Pumps **bearing the „ Ex ” mark on their rating plates are approved for the pumping of potentially explosive atmospheres** according to their ATEX classification imprinted on their rating plate, but they are **not approved for operation in potentially explosive atmospheres** (see section „ Ex Important information: Equipment marking (ATEX)“, pg. 25).
- ➔ The pumps are **not suitable** to pump any of the substances listed below.
Do not pump:
 - **unstable substances**
 - substances which react explosively under **impact** (mechanical stress) without air
 - substances which react explosively when being exposed to **elevated temperatures** without air,
 - substances subject to **auto-ignition**,
 - substances which are **inflammable without air**
 - **explosive substances.**
- ➔ The pumps are **not approved** for operation below ground. **Do not operate** the pump **below ground.**

⚠ CAUTION

- **Do not pump** substances which may form **deposits** inside the pump. The pumps are not suitable for pumping substances which may form deposits inside the pump. Deposits and condensate in the pump may lead to increased temperatures even to the point of exceeding the maximum permitted temperatures.
- Check the inlet and outlet of the pump, if there is a danger of forming **deposits** inside the pump, e.g., in the pump chambers (the pump chamber is the part

between diaphragm and head cover. See section „Replacing diaphragms and valves“, pg. 103). Inspect the pump chambers regularly and clean if necessary.

- **Consider interactions and chemical reactions of the pumped media.** Ensure that the materials of the pump's wetted parts are compatible with the pumped substances, see section „Technical data“, pg. 27. When changing the substances pumped, we recommend purging the pump with air or inert gas prior to changing the pumped media. Purging the pump will pump out residues and it will reduce the possibility of reactions of the pumped substances with each other and with the pump's materials.

Safety during operation

⚠ DANGER

- ➔ Adopt suitable measures to prevent the release of dangerous, toxic, explosive, corrosive, noxious or polluting fluids, vapors and gases. To prevent any emission of such substances from the pump outlet, install an appropriate collecting and disposal system and take protective action for pump and environment.
- ➔ You must take suitable precautions to prevent any formation of explosive mixtures in the pump chamber or at the outlet of the pump. In case, e.g., of a diaphragm failure, mechanically generated sparks, hot surfaces or static electricity may ignite these mixtures. Use inert gas for gas ballast or venting, if necessary.
- ➔ Drain appropriately or otherwise remove any potentially explosive mixtures at the outlet of the pump, or dilute them to non-explosive concentrations.
- ➔ Never operate this pump if it has a damaged cord or plug.

⚠ WARNING

- ☞ If the pump is not working properly, has been dropped or has fallen into water, contact your pump service provider.

- ☞ Prevent any part of the human body from coming into contact with vacuum.
- ☞ Make sure that the exhaust pipeline cannot become blocked.
- ☞ Check the overpressure safety relief device at the exhaust waste vapor condenser at appropriate intervals.
- ☞ Avoid clogging of the exhaust vapor condenser caused by deposits or freezing solvents.
- ☞ **Attention:** At pressures above approximately 795 Torr (1060 mbar) the pressure reading becomes incorrect due to saturation of the pressure transducer. The display flashes. Release pressure immediately! Risk of bursting!
- ☞ Comply with applicable regulations when disposing of chemicals. Take into consideration that chemicals may be contaminated. Take adequate precautions to protect people from the effects of dangerous substances (chemicals, thermal decomposition products of fluoroelastomers). Use appropriate protective clothing and safety goggles.
- ☞ Interruption of the pump (e.g., due to power failure), failure of connected components or of parts of the supply, or change in parameters must not be allowed to lead to dangerous conditions. In case of a diaphragm failure or in case of a leak in the manifold, pumped substances might be released into the environment or into the pump housing or motor.
Comply with all notes regarding proper use of the pumps, as well as operation and maintenance guidance.
- ☞ The residual **leak rate of the equipment** might render possible an exchange of gas, albeit extremely slight, between the environment and the vacuum system. Adopt suitable measures to prevent contamination of the pumped substances or the environment.

PC 3001 VARIO^{pro} TE:

- ☞ Cold surfaces can absorb a great amount of gas, which may expand abruptly in case of warming. This may lead to unmanageable overpressure in the system, creating a risk of bursting!
- ☞ Check the coolant level of the condenser at appropriate intervals.
- ☞ **Attention:** Coolant may overflow unexpectedly, e.g., in case of large amounts of gas.
- ☞ Do not overfill the condenser. Lowest permissible coolant temperature: -112°F (-80°C).
- ☞ Maximum operating pressure: 16 psi (1.1 bar) absolute.

CAUTION

- Ensure that no parts of your clothing, hair or fingers can be caught or drawn in at the inlet of the pump. Never insert fingers or drop any other object into the inlet or outlet.
- Pumping at high inlet pressure may lead to overpressure at the gas ballast valve. Pumped gases or condensate might be expelled if the valve is open. If an inert gas supply is connected to the gas ballast, ensure that its inlet pipeline is not contaminated.
- You must take suitable precautions to prevent any dangerous situation from arising if the controller starts the pump, switches a coolant valve or opens a venting valve.
- **Attention:** If the controller is set to **Autostart**, the process will start immediately after a power failure without pressing any further key. It is your responsibility to ensure that automatic start-up of the system will not lead to any dangerous condition. Provide appropriate safety measures. Check **prior to starting the process** whether the option "*Autostart*" (menu: configuration) is enabled.
- Pay attention to the safety symbol "hot surfaces" on the equipment. Depending on operation conditions and ambient conditions dangers due to hot surfaces may



arise. Hot parts may cause burns if touched. Adopt suitable measures to prevent any danger arising from hot surfaces. Ensure that hot surfaces of the pump do not cause burns. Provide a suitable contact guard if necessary.

- Ensure that the **coolant outlet pipe** at the waste vapor condenser is always free and that it cannot get blocked.

PC 3001 VARIO^{pro} TE:

- Comply with all applicable safety measures and requirements when using cryogenic coolants (e.g., dry ice).

Attention: Coolant media may cause severe frostbite when coming in contact with skin!

- Prior to every use: Inspect the condenser for faults. There must be no damage on the glass surface. Do not use damaged components.
- Use only transport receptacles intended for coolants.
- Wear safety glasses and protective gloves.
- Do not clamp the covers of condensers or coolant receptacles. Allow pressure equalization between coolant and atmosphere.

NOTICE

Prevent the backpressure of gases and the backflow of condensates at the outlet.

Check the liquid level in the catchpots regularly and drain condensate in time to prevent overflowing. Install a level sensor (see „Accessories“, pg. 98) for monitoring, if necessary.

Provide appropriate protective measures to allow for the possibility of failure and **malfunction**. The protective measures must also allow for the requirements of the respective application.

The CVC 3000 controller is powered by a short-circuit-proof wide-range power supply with integrated overload protection.

A temperature sensor at the circuit board protects the motor. In case of excess temperature, the pump is switched off.

Note: Only manual reset is possible. Disconnect the pump from the power source. Identify and eliminate the cause of failure.

Maintenance and repair

NOTICE

In order to comply with laws (occupational, health and safety regulations, safety at work law and regulations for environmental protection) vacuum pumps, components and measuring instruments can only be returned when certain procedures (see section „**Repair - Maintenance - Return - Calibration**“, pg. 117) are followed.

Take advantage of our service seminars, which put special focus on the maintenance and repair of vacuum pumps. For details and for the online "Instructions for repair" manual see www.vacuubrand.com.

In normal use, the lifetime of the diaphragms and valves is typically 15,000 operating hours. Bearings have a typical durability of 40000 h.

! DANGER

➔ **Ensure that the pump cannot be operated accidentally. Never operate the pump if covers or other parts of the pump are disassembled.**



➔ **Switch off the pump. Disconnect the electrical power cord and wait two minutes** before starting maintenance to allow the capacitors to discharge.

➔ **Note:** The pump may be contaminated with process chemicals, which have been pumped during operation. Ensure that the pump is completely decontaminated before maintenance commences.

⚠ WARNING

- ☞ Take adequate precautions to protect people from the effects of dangerous substances if contamination has occurred. Use appropriate protective clothing, safety goggles and protective gloves.
- ☞ **Wear parts have to be replaced regularly.**
- ☞ **Never operate a defective or damaged pump.**

- ☞ Vent the pump before starting maintenance. Isolate the pump and other components from the vacuum system. Allow sufficient cooling of the pump. Separate the pump from the coolant circuit and drain condensate, if applicable.

NOTICE

Clean polluted surface with a clean, slightly moistened cloth. To moisten the cloth we recommend water or mild soap.

Ensure that **maintenance** is done only by suitably trained and supervised technicians. Ensure that the maintenance technician is familiar with the safety procedures which relate to the products processed by the pumping system. Only dismantle the pump as far as necessary.

Important information: Equipment marking (ATEX)

Only valid for products with ATEX marking. If the ATEX marking is shown on the rating plate of the respective product, VACUUBRAND GMBH + CO KG assures, that the device complies with the provisions of the directive 2014/34/EU. The applied harmonized standards are indicated in the EC Declaration of Conformity of the Machinery (see instructions for use).

VACUUBRAND equipment bearing the ATEX mark (see rating plate)

The classification according to ATEX is only valid for the inner part (wetted part, pumped gas or vapor) of the equipment. The equipment is not suitable for use in external, potentially explosive atmospheres (environment).

The overall category of the equipment depends on the connected components. If the connected components do not comply with the classification of the VACUUBRAND equipment, the specified category of the VACUUBRAND equipment is no longer valid.

Vacuum pumps and vacuum gauges in category 3 are intended for connection to equipment in which during normal operation explosive atmospheres caused by gases, vapors or mists normally don't occur; or, if they do occur, are likely to do so only infrequently and for a short period only. Equipment in this category ensures the requisite level of protection during normal operation.

The use of gas ballast or the operation of venting valves is only permitted if thereby explosive atmospheres normally don't occur in the interior of the equipment or, if they do occur, are likely to do so only infrequently and for a short period.

The pumps are marked with "X" (according to DIN EN ISO 80079-36:2016), i.e., restrictions of the operation conditions:

- The equipment is designated for a low degree of mechanical stress and has to be installed in a way so that it cannot be damaged from outside.
Pumping units have to be installed so that they are protected against shocks from the outside and against glass splinters in the event of breakage (implosion).
- The equipment is designated for an ambient and gas inlet temperature during operation of +10 to +40°C. Never exceed these ambient and gas inlet temperatures. If pumping / measuring gases which are not potentially explosive, extended gas inlet temperatures are permissible. See instructions for use, section “Gas inlet temperatures” or “Technical data”.

After any intervention at the equipment (e.g., repair / maintenance) the ultimate vacuum of the pump has to be checked. Only if the pump achieves its specified ultimate vacuum is the pump's leak rate low enough to ensure that no explosive atmospheres will occur in the interior of the equipment.

After any intervention at the vacuum sensor, the leak rate of the equipment has to be checked.



Attention: This manual is not available in all languages of the EU. The user must not operate the device if he does not understand this manual. In this case a technically correct translation of the complete manual has to be available. The manual must be completely read and understood before operation of the device. All specified measures must be applied, or else must be replaced by equivalent measures at the user's own risk.

Technical data

General technical data valid for all pumping units		
ATEX approval if the ATEX marking is shown on the rating plate Inner part (pumped gases)		II 3/- G Ex h IIC T3 Gc X Internal Atm. only Tech.File: VAC-EX02
Maximum pumping speed (ISO 21360)	cfm (m ³ /h)	1.2 (2.0)
Ultimate vacuum (absolute) without gas ballast*	Torr (mbar)	1.5 (2)
Ultimate vacuum (absolute) with gas ballast*	Torr (mbar)	3 (4)
Maximum permissible inlet and outlet pressure (absolute)	psi (bar)	16 (1.1)
Maximum permissible pressure difference between inlet and outlet	psi (bar)	16 (1.1)
Maximum permissible pressure (absolute) at gas ballast valve	psi (bar)	17.5 (1.2)
Permissible ambient temperature storage / operation	°F (°C)	14 to 140 / 50 to 104 (-10 to +60 / +10 to +40)
Permissible relative atmospheric moisture during operation (no condensation)	%	30 to 85
Maximum permissible installation altitude above mean sea level	ft (m)	6500 (2000)
Rated motor power	hp (kW)	0.21 (0.16)
No-load speed**	rpm	0 - 3000
Maximum permissible range of supply voltage (±10%) Attention: Observe specifications of rating plate!		100-230 V~ 50/60 Hz
Maximum rated current at: 100-230 V~ 50/60 Hz	A	1.6-0.7
Device fuse Fuse of VACUU•BUS 24V DC supply		7AF fuse on the circuit board 1.1AT slow blow fuse (with automatic reset) on the circuit board
Motor protection		current limitation (temperature sensor on the circuit board)
Overvoltage category		II

General technical data valid for all pumping units		
Degree of protection IEC 60529		IP 20
Degree of protection UL 50E		type 1
Pollution degree		2
Volume of catchpot	quarts (ml)	0.52 (500)
A-weighted emission sound pressure level*** (uncertainty K_{pA} : 3 dB(A))	dB(A)	42

Type		PC 3001 VARIO^{pro}	PC 3001 VARIO^{pro} IK
Inlet		hose nozzle for tubing I.D. 1/4" / 3/8" (hose nozzle DN 6/10 mm)	hose nozzle for tubing I.D. 1/2" (hose nozzle DN 13 mm)
Outlet		hose nozzle for tubing I.D. 3/8" (hose nozzle DN 10 mm)****	
Coolant connection (waste vapor condenser)		hose nozzle for tubing I.D. 1/4" - 5/16" (hose nozzle DN 6-8 mm)	
Maximum permissible pressure of coolant at vapor condenser	psi (bar)	87 (absolute) (6 (absolute))	
Permissible range of coolant temperature (vapor condenser)	°F (°C)	5 to 68 (-15 to +20)	
Dimensions L x W x H approx.	in (mm)	11.8 x 12.0 x 15.7 (300 x 306 x 400)	12.2 x 12.3 x 15.7 (309 x 312 x 400)
Weight approx.	lbs. (kg)	17.0 (7.7)*****	18.3 (8.3)

* Ultimate vacuum at setting "Pump down" at speed "HI"

** Running smoothly only at motor speeds higher than 200 rpm

*** Measurement according to EN ISO 2151:2004 and EN ISO 3744:1995 at 1500rpm and ultimate vacuum with exhaust tube at outlet.

**** PC 3001 VARIO^{pro} without condenser: Hose nozzle with silencer

***** PC 3001 VARIO^{pro} without condenser: 12.2 (6.9)

Type	PC 3001 VARIO ^{pro} TE	PC 3001 VARIO ^{pro} emission condenser Peltronic
Inlet	hose nozzle for tubing I.D. 1/4" / 3/8" (hose nozzle DN 6/10 mm)	
Outlet	hose nozzle for tubing I.D. 3/8" (hose nozzle DN 10 mm)	hose nozzle for tubing I.D. 5/16" (hose nozzle DN 8 mm)
Permissible range of coolant temperature	°F (°C) -112 to 68 (-80 to +20)	-
Coolant capacity	quarts (ml) 0.3 (275)	-
Dimensions L x W x H approx.	in (mm) 13.2 x 10.2 x 18.9 (335 x 260 x 480)	11.8 x 14.6 x 15.7 (300 x 370 x 400)
Weight approx.	lbs. (kg) 18.1 (8.2)	24.9 (11.3)

Controller	CVC 3000
Pressure transducer	ceramic diaphragm (alumina), capacitive, absolute pressure, gas type independent
Display	LCD graphic display, illuminated
Pressure units / scale (selectable)	Torr, mbar or hPa
Measuring range (absolute)	810 - 0.1 Torr (1080 - 0.1 mbar)
Maximum control range with internal pressure transducer (absolute)*	795 - 0.1 Torr (1060 - 0.1 mbar)
Resolution	0.07 Torr (0.1 mbar)
Maximum permissible pressure at pressure transducer (absolute)	1125 Torr (1.5 bar)
Maximum permissible temperature of gaseous media**	continuous operation: 104°F (40°C), for short periods (less than 5 minutes) up to 176°F (80°C)
Measurement uncertainty (absolute) after careful adjustment and at constant temperature	<± 0.75 Torr (1 mbar)
Temperature coefficient	<± 0.05 Torr/K (0.07 mbar/K)
Ambient temperature range (operation)	50°F to 104°F (10°C to +40°C)
Ambient temperature range (storage)	14°F to 158°F (-10°C to +70°C)
Permissible relative atmospheric moisture during operation (no condensation)	30% to 85%
Maximum permitted current of connected valves (connected components)	4A
Venting connection	hose nozzle for hose I.D. 3/16" (4-5 mm)
Maximum admissible pressure at venting connection	17.4 psi (1.2 bar) absolute
Interface	RS-232 C

* The actual vacuum control range in your application might be reduced due to ultimate vacuum of the pump, volume of gas present, etc.

** if pumping potentially explosive atmospheres: 50 °F to 104 °F (+10°C to +40°C)

NOTICE

See manual of Peltronic emission condenser for technical data!

We reserve the right for technical modification without prior notice!

Gas inlet temperatures

Operating condition	Inlet pressure	Permitted range of gas temperatures at inlet
Continuous operation	> 75 Torr (100 mbar) (high gas load)	➔ 50 °F to 104 °F (+10°C to +40°C)
Continuous operation	< 75 Torr (100 mbar) (low gas load)	➔ 32 °F to 140 °F* (0°C to +60°C*)
Short-time (< 5 minutes)	< 75 Torr (100 mbar) (low gas load)	➔ 14 °F to 176 °F* (-10°C to +80°C*)

* if pumping potentially explosive atmospheres: 50 °F to 104 °F (+10°C to +40°C)

Wetted parts

Components	Wetted materials
Pump	
Housing cover	PTFE
Head cover	ETFE carbon fiber reinforced
Diaphragm clamping disc	ETFE carbon fiber reinforced
Diaphragm	PTFE
Valve	FFKM
Pumping unit	
Inlet pumping unit	PPS (PC 3001 VARIO ^{pro} IK: PP)
Outlet pumping unit	PET (PC 3001 without emission condenser: PTFE carbon reinforced)
Outlet pumping unit (PC 3001 VARIO ^{pro} emission condenser Peltronic)	ETFE / ECTFE
Tubing	PTFE
Screw-in fittings	ETFE / ECTFE
O-ring at the catchpot	Fluoroelastomer
Overpressure safety relief device at exhaust waste vapor condenser	Silicone rubber / PTFE film
Distribution head (inlet)	PPS glass fiber reinforced / PP (blind plug)
Waste vapor condenser IK / EK / TE, catchpot	Borosilicate glass
Emission condenser Peltronic	ETFE / ECTFE / PP / PA
Silencer	PBT / PVF / rubber
CVC 3000	
Sensor	Aluminum oxide ceramic
Sensor housing	PPS / glass fiber
Sensor seal	Chemically resistant fluoroelastomer
Venting valve seal	FFKM

We reserve the right for technical modification without prior notice!

Abbreviations

EK:	Waste vapor condenser (emission condenser)
ETFE:	Ethylene/Tetrafluoroethylene
ECTFE:	Ethylene/Chlorotrifluoroethylene
FFKM:	Perfluoro elastomer
FPM:	Fluoroelastomer
IK:	Waste vapor condenser (inlet condenser)
PA:	Polyamide
PBT:	Polybutylene terephthalate
PET:	Polyethylene terephthalate
PP:	Polypropylene
PPS:	Polyphenylene sulfide
PTFE:	Polytetrafluoroethylene
PVF:	Polyvinyl fluoride
TE:	Dry ice waste vapor condenser

Pump parts

Position	Component
1	MD 1C VARIO chemistry diaphragm pump
2	CVC 3000 controller
3	Mains connection
4	ON/OFF switch
5	Inlet
6	Outlet
7	Gas ballast valve
8	Handle
9	Exhaust waste vapor condenser

Position	Component
10	Catchpot
11	Coolant inlet
12	Coolant outlet
13	Dry ice vapor condenser
14	Distribution head
15	Inlet condenser
16	Peltronic emission condenser
17	Overpressure safety relief device

PC 3001 VARIO^{pro}

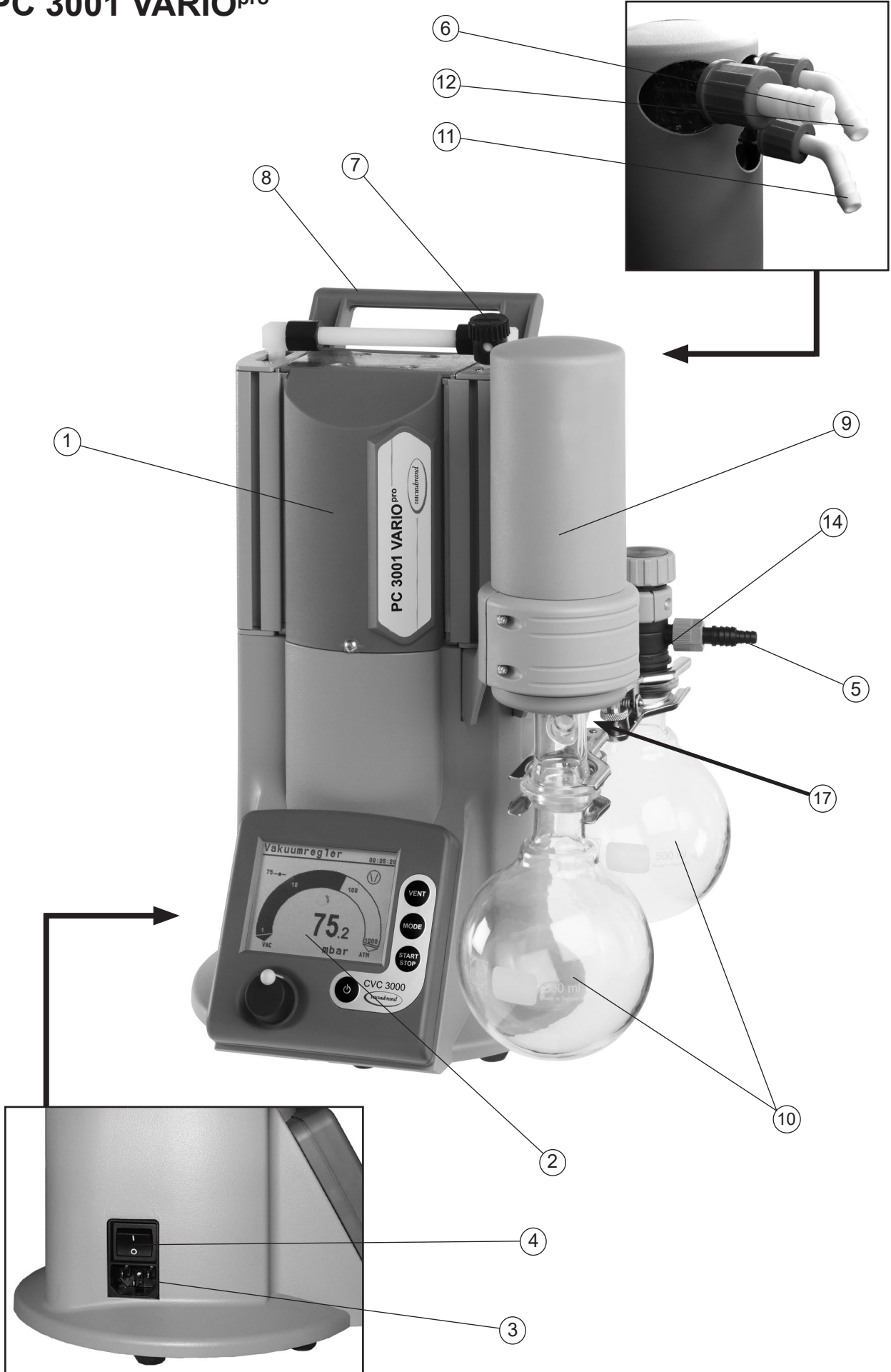

PC 3001 VARIO^{pro} TE



PC 3001 VARIO^{pro} IK

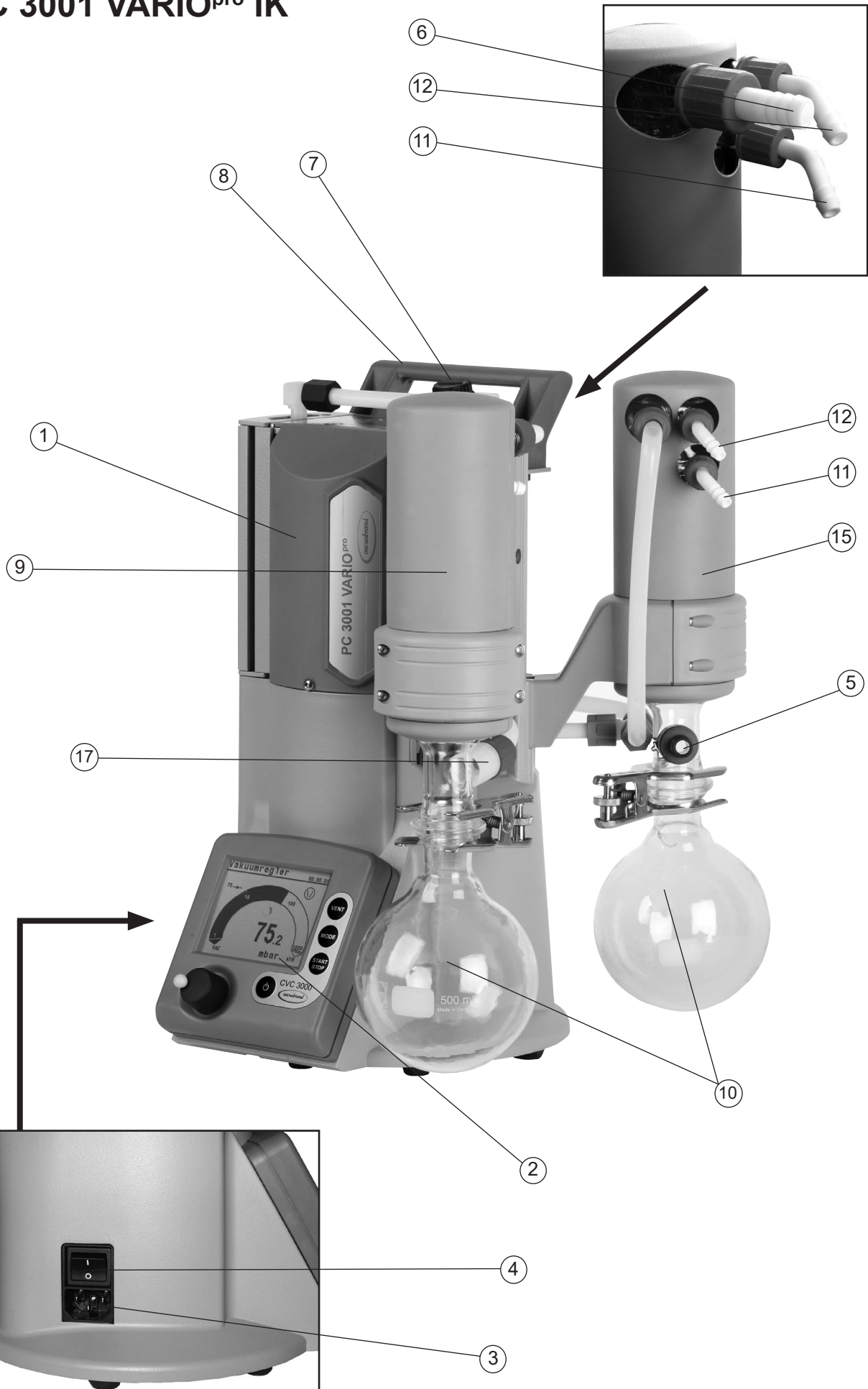

PC 3001 VARIO^{pro} emission condenser Peltronic

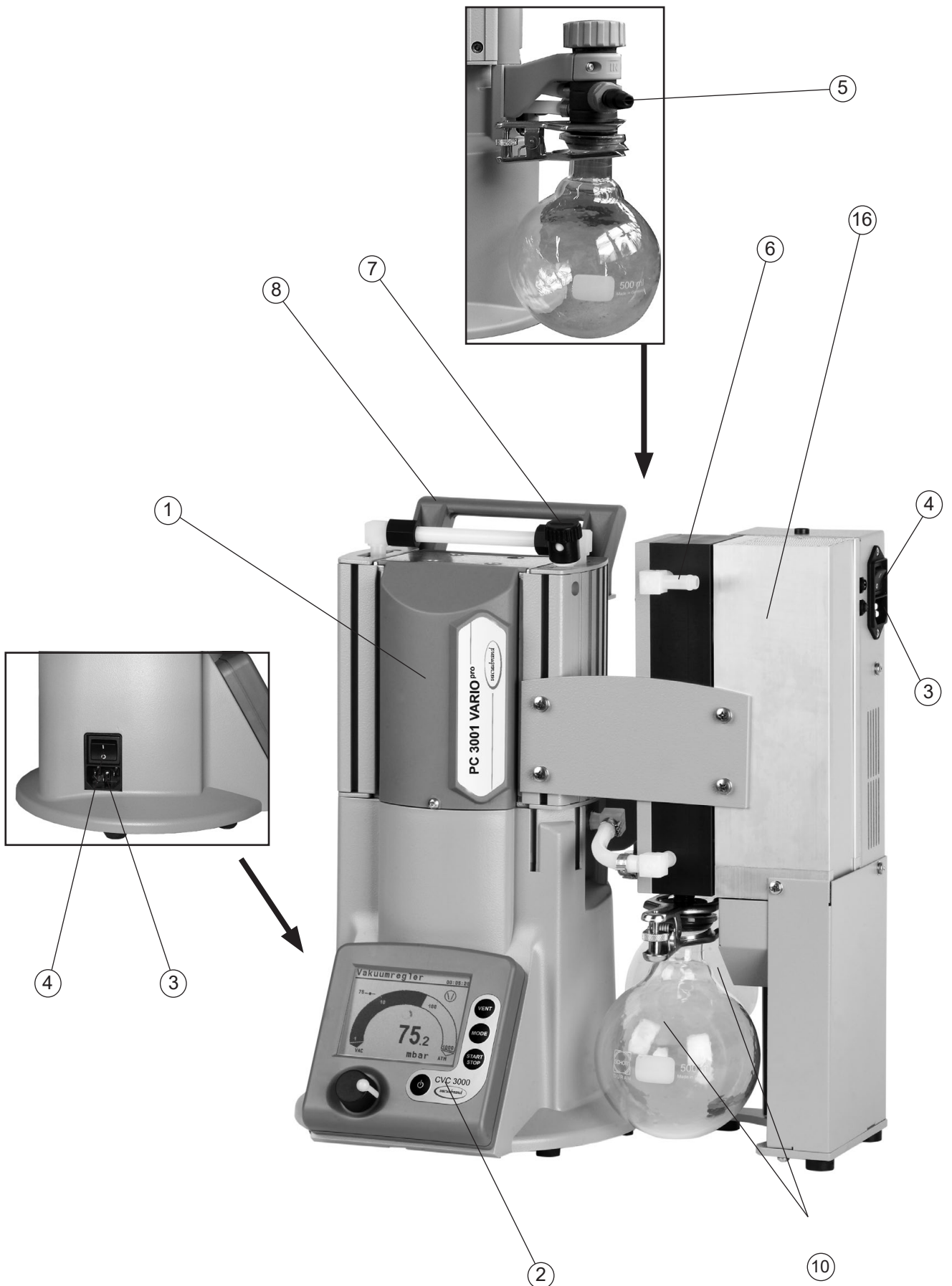

PC 3001 VARIO^{pro} (without exhaust waste vapor condenser)



Rear side CVC 3000

jacks for connection of VACUU•BUS components (e.g., coolant valve)

connection plug of the VACUU•BUS line to VARIO pump

serial interface RS-232 C

venting connection

rating plate

measurement connection

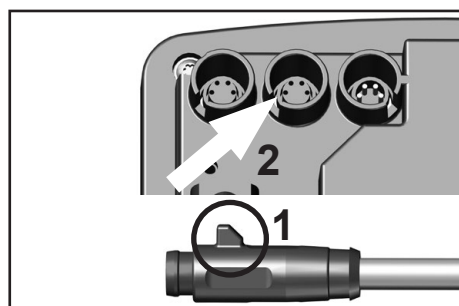
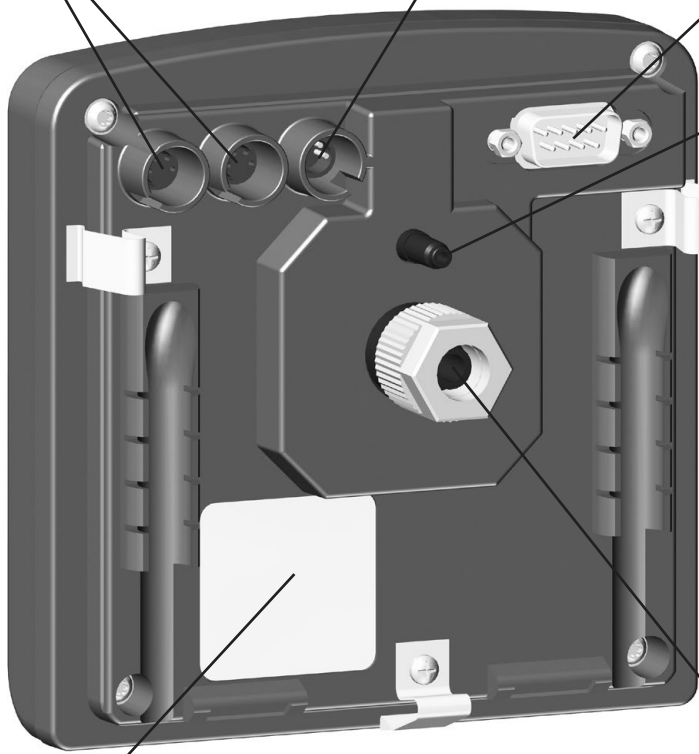

Depending on technical version the connections of the VACUU•BUS cables are equipped with a nib.

When connecting the VACUU•BUS connections to the rear side of the controller position the nib (1) of the VACUU•BUS connection in the notch (2) of the controller connections.

Use and operation

When switching on the controller CVC 3000 for the very first time, a menu to select the language of the controller menu is displayed. Select the desired language (e.g., "English") by turning the selection knob and press to confirm. Then select the pressure unit ("mbar", "Torr" or "hPa") in the same way.

It is possible to access the language selection menu at any time by switching on the controller while keeping the selection knob pressed.

Installing a pump in a vacuum system

DANGER

- ➔ If dangerous or polluting fluids could be released at the outlet, install an appropriate system to catch and dispose of those fluids.

WARNING

- ☞ Connect a gas-tight exhaust line at the pump outlet if necessary. Always vent exhaust gases appropriately (e.g., into a fume hood).
- ☞ Never block the gas outlet. The exhaust line must always be free of obstructions (no back pressure) to ensure an unimpeded discharge of gas. The cross-section of the outlet tubing must be at least the size of the pump's exhaust connection.
- ☞ Maximum permissible pressure: 21.8 psi (1.5 bar) absolute.
- ☞ **Attention:** At pressures above approximately 795 Torr (1060 mbar) the pressure reading becomes incorrect due to saturation of the pressure transducer. The display will flash. Release pressure immediately! Risk of bursting!
- ☞ Particles and dust must not be aspirated. If necessary, you must install appropriate filters. You must ensure their suitability concerning gas flow, chemical resistance and resistance to clogging prior to use.

- ☞ Make sure ventilation is adequate, especially if the pump is installed in an enclosure, or if the ambient temperature is elevated. Provide external ventilation, if necessary.

CAUTION

- Reduce the transmission of vibration. Prevent mechanical load due to rigid pipelines. Insert elastic hoses or flexible elements as couplings between the pump and rigid pipes.
Note: Flexible elements will compress or flatten when evacuated if not designed for use under vacuum.
- Hose connections at the pump inlet must always be gas tight.
- A power failure may cause accidental ventilation of the pump, especially if the gas ballast valve is open. If this constitutes a potential source of danger, take appropriate safety measures.
- Check the power source and the pump's rating plate to be sure that the power source and the equipment match in voltage, phase, and frequency.

NOTICE

The ON/OFF switch and the mains connection are at the left side of the pumping unit. The mains plug is a disconnecting device to separate the pump from the supply voltage. Ensure that the mains plug is easily accessible at all times to allow the separation of the device from the power supply.

After switching off the pump, wait minimum 60 sec. before switching on again.

Make sure ventilation is adequate to maintain recommended operating temperature. Keep a minimum distance of 2 in (5 cm) between the cooling fan and surrounding items (e.g., housing, walls, etc.), or else install an external automatic ventilation system.

Use connecting hoses with large diameter and keep them as short as possible to avoid flow losses. Locate the pump as closely as possible to the application.

Always install outlet tubing descending from the pump or provide other measures to avoid backflow of condensate towards the pump.

Use a suitable valve to isolate the pump from the vacuum application. This is to allow the pump to warm up before pumping condensable vapors and to clean the pump after use before it is switched off.

When assembling, ensure **vacuum-tightness**. After assembly, check the whole system for leaks.

Secure hose connections at the pump appropriately, e.g., with hose clamps, to protect against accidental detachment.

To reduce pump noise emanating from the pump exhaust port, connect an exhaust hose or use a silencer (see „Accessories“, pg. 98).

The VACUUBRAND controller CVC 3000 can only be operated with components compatible with the VACUUBRAND VACUU•BUS system, (see „Accessories“, pg. 98).

The vacuum controller CVC 3000 controls VACUUBRAND diaphragm pumps NT VARIO and VARIO-B, pumping units PC 30xx VARIO, and optional coolant and venting valves. Connected components (e.g., venting valve, level sensor, external pressure transducer 3000 series) are automatically identified and configured. Identical components must be configured beforehand; information upon request.

Do not use more than one controller within the same VACUU•BUS system.

Several controllers in the same VACUU•BUS system will interfere with each other and result in error messages of the connected components (pumps, valves).

CVC 3000

The CVC 3000 is equipped with an internal capacitive pressure transducer with ceramic diaphragm. It measures the actual pressure independently of the gas type, and with reference to the vacuum, i.e., absolute.

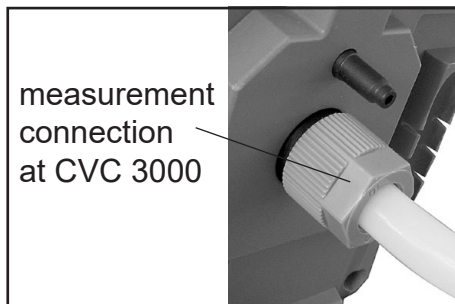

- Condensate and deposits will affect the measurement results. Clean the pressure transducer, if necessary. See section „Cleaning the pressure transducer“, pg. 87.

Connecting components at the controller:



At the rear side of the controller are connections for e.g., an optional coolant valve and/or an external pressure transducer and/or an external venting valve, as well as a venting connection and the serial interface RS 232C.

- Pull the controller out of the housing. Be careful not to disconnect the measuring connection (PTFE tube)!
- Insert the cable of the component to be connected underneath the housing and plug into the controller. Do not apply off-axis forces when assembling or removing plug connections! Observe correct orientation of the plug.
- Insert controller into the housing.

Separator at inlet and exhaust waste vapor condenser:

Assembling the hose nozzle with union nut:

- ➔ Take the hose nozzle with attached compression ferrule and union nut out of the catchpot and put onto inlet connection.
- ➔ Tighten the union nut by hand until you can feel the stop. Then tighten an additional 1/4 rotation with an

open-ended wrench (size 17 mm) for final installation.

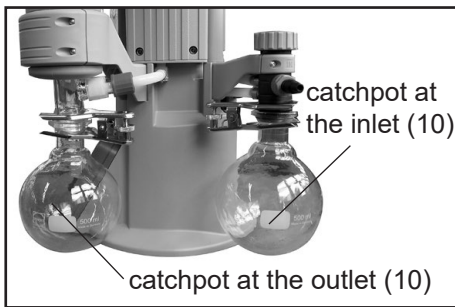

Catchpots:

The catchpot at the inlet protects against droplets and particles from entering the pump.

- ☞ Enhances lifetimes of diaphragms and valves.
- ☞ Improves vacuum performance in applications with condensable vapors.

Both catchpots are coated with a protective layer to protect against shattering in case of breakage or implosion.

- ➔ Assemble the catchpots at the inlet and at the outlet using joint clips.

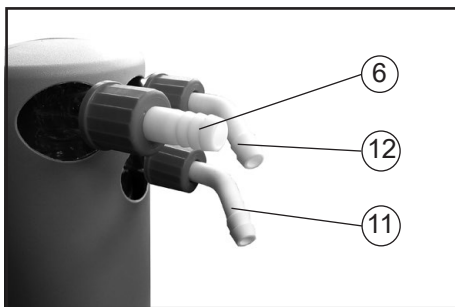

Exhaust waste vapor condenser (PC3001 VARIO^{pro}):

- ➔ Assemble the hose nozzles for coolant inlet (11) and coolant outlet (12) tubing and for the gas outlet (6) at the exhaust waste vapor condenser.

The **exhaust waste vapor condenser** enables an efficient condensation of the pumped vapors at the outlet.

- ☞ No backflow of condensates.
- ☞ Controlled recovery of condensates.
- ☞ Close to 100% solvent recovery.
- ☞ The isolation cover protects against glass splinters in case of breakage, acts as thermal insulation to avoid condensation of humidity and is intended to absorb shocks.

- ➔ Attach the tubing of the coolant circuit to the respective hose nozzles (hose nozzles for tubing I.D. 1/4"-5/16" (6-8 mm), see image) at the waste vapor condenser.

NOTICE

Check all hose connections prior to starting operation of the cooling system.

Secure coolant hoses at the hose nozzles (e.g., with hose clamps) to prevent their accidentally slipping off.

⚠ DANGER

- ➔ Prevent the discharge of dangerous gases and vapors to the surrounding atmosphere. If appropriate, connect the exhaust line to a suitable treatment system.

⚠ WARNING

- ☞ Never block the gas outlet ((8) hose nozzle for tubing I.D. 3/8" (10 mm)). The exhaust hose has always to be unobstructed and without back pressure to enable an unhindered discharge of gases and protect the pump valves from damage.

⚠ CAUTION

- **Note:** Install the hoses of the cooling system in a way to avoid the flow / dripping of condensed water onto the pumping unit (especially cables and electronic parts, see also IP degree of protection, „Technical data“, pg. 27.
- Ensure that the **coolant outlet tubing** is always unobstructed and that it cannot get blocked.
- Maximum permissible coolant pressure at the exhaust waste vapor condenser: 87 psi (6 bar) absolute. Outlet flow must always be unhindered.
- Comply with the maximum permissible coolant pressures of additional components in the coolant circuit (e.g., coolant valve).
- Avoid overpressure in the coolant circuit (e.g., caused by blocked or squeezed coolant hoses).
- Only install the optional coolant valve in the supply line of the exhaust waste vapor condenser.

Notes regarding the (dry) ice condenser (PC 3001 VARIO^{pro} TE)



The **exhaust waste vapor condenser** enables an efficient condensation of the pumped vapors at the outlet.

- ☞ Close to 100% solvent recovery.
- ☞ The isolation cover protects against glass splinters in case of breaking, acts as thermal insulation to avoid the condensation of humidity and is intended to absorb shocks.

! DANGER

- ➔ Adopt suitable measures to prevent the formation of explosive or flammable mixtures, use inert gas for venting if necessary.
- ➔ Prevent the discharge of dangerous gases and vapors to the surrounding atmosphere. If appropriate, connect the exhaust line to a suitable treatment system.
- ➔ Adopt suitable measures to prevent the release of dangerous, toxic, explosive, corrosive, noxious or polluting fluids, vapors and gases when disposing of condensates.

! WARNING

- ☞ Cold surfaces can absorb a great amount of gas, which may expand abruptly in case of warming. This may lead to unmanageable overpressure in the system, creating a risk of bursting!
- ☞ Check the coolant level of the condenser at appropriate intervals.
- ☞ **Attention:** Coolant may overflow unexpectedly, e.g., in case of large amounts of gas.
- ☞ Do not overfill the condenser. Lowest permissible coolant temperature: -112°F (-80°C).
- ☞ Maximum operating pressure: 16 psi (1.1 bar) absolute.
- ☞ Never block the gas outlet ((6) hose nozzle for tubing I.D. 3/8" (10 mm)). The exhaust hose has always to be unobstructed and without back pressure to enable an unhindered discharge of gases and protect the pump valves from damage.

! CAUTION

- Prior to every use: Inspect the condenser for faults. There must be no damage on the glass surfaces. Do not use damaged components.
- Use only transport receptacles intended for coolants.
- Use safety glasses and protective gloves.
- Do not clamp the covers of condensers or coolant receptacles. Allow pressure equalization between coolant and atmosphere.
- Comply with all applicable safety measures and requirements when using cryogenic coolants.

NOTICE

Use the equipment **only as intended**, that is, for condensation of vapors at the pump outlet or inlet.

Suitable coolants: e.g., dry ice or ethanol-dry ice mixture or water-ice mixture.



- ➡ Remove cap. Fill coolant into the coolant chamber. Put cap back in place. Do not clamp the cap.
- ☞ Check coolant level at appropriate intervals.
- ➡ Check level of condensate at appropriate intervals and drain condensate if necessary.
- ☞ Wait until the condensate has liquefied, if necessary.

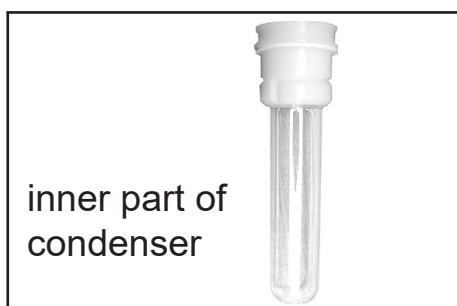

- ☞ Separate the inner part of the condenser from the vacuum installation to drain the coolant.
- ➡ Remove the cap on top of the condenser. Turn the inner part of the condenser and lift to pull it out. Comply with regulations when disposing of chemicals.
- ☞ When reassembling check for the correct position of the seal between inner and outer parts of the condenser.

Notes concerning the operation of the inlet condenser IK

WARNING

- ☞ **Attention:** The inlet condenser has **no overpressure safety relief device**.

CAUTION

- **Note:** Install the hoses of the cooling system in a way to avoid the flow / dripping of condensed water onto the pumping unit (especially cables and electronic parts), or use thermally insulated hoses to prevent condensation.
- Ensure that the **coolant outlet tubing** at both condensers is always unobstructed and that it cannot get blocked.

- Water pressure shock at the condensers may cause breakage of the condenser coil!

Notes concerning the operation of the Peltronic emission condenser

NOTICE

Read the manual of the Peltronic emission condenser and observe the instructions contained in that manual!

Assembling the Peltronic emission condenser:



- Assemble the Peltronic emission condenser with two attachment screws (Phillips screwdriver size 2) to the pumping unit (a).
- Assemble the hose connection between pump outlet and condenser inlet (b).
- Slip connecting tube onto hose connection of the Peltronic emission condenser. Secure with hose clip.

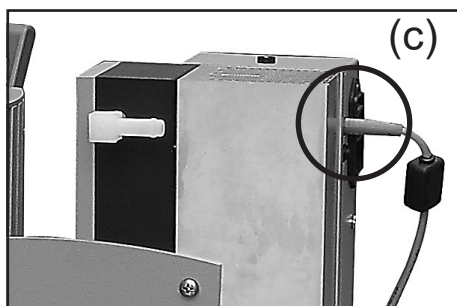

- Connect the VACUU•BUS cable from the CVC 3000 controller to the Peltronic emission condenser (c).

Notes concerning the operation of pumping units with silencer

NOTICE

Attention: Dust-laden gases, deposits and condensed solvent vapor can restrict air flow out the silencer. The resultant back pressure can lead to damage of pump bearings, diaphragms, and valves. Under those conditions, a silencer must not be used.

During operation

DANGER

- ➔ Vent and dispose of **potentially dangerous gases or vapors** at the outlet of the pump appropriately.

WARNING

- ☞ Due to the high compression ratio, the pump might generate overpressure at the outlet. Check pressure compatibility with system components (e.g., exhaust tubing or exhaust valve) at the outlet. Ensure that the pump outlet is neither blocked nor restricted.

- ☞ **Maximum ambient temperature:** 104 °F (40 °C)
Check the maximum temperatures, if installing the pump in a cabinet or a housing. Make sure ventilation is adequate, especially if the ambient temperature is elevated.

CAUTION

- If the pump is installed at an altitude of more than 6500 ft (2000 m) above mean sea level, check compatibility with applicable safety requirements, and adopt suitable measures. There is a risk of the motor overheating due to insufficient cooling.
- Check compatibility with the **maximally permitted pressure** at outlet and the **maximum pressure difference** between inlet and outlet ports.

NOTICE

Do not start the pump if the **pressure difference between inlet and outlet ports exceeds max. 16.0 psi (1.1 bar)**. Attempts to start the pump at higher pressure difference may cause stalling and damage of the motor.

If pumping condensable vapors (water vapor, solvents, etc.), let the pump run with **gas ballast** to help purge any condensation in the pump.

Prevent internal condensation, transfer of liquids or dust. The diaphragms and valves will be damaged, if liquids are pumped in significant amounts.
Check the pump regularly for external soiling and deposits.

Clean the pump if necessary to avoid an increase of the pump's operating temperature.

Operation with silencer (optional) at the outlet: Operating the pump at a high inlet pressure or pumping dusty gases for a long time may cause clogging of the silencer. Check the silencer regularly and replace if necessary.

A temperature sensor at the circuit board protects the motor. In case of excess temperature, the pump is switched off.

Note: Only manual reset is possible. Disconnect the pump from the power source. Identify and eliminate the cause of failure.

Check ventilation slots regularly for dust/dirt. Clean if necessary. Avoid overheating (e.g., due to hot process gases).

A warm up period (approximately 15 min.) is required to ensure that the rated ultimate vacuum and pumping speed are attained.

Important notes regarding the use of gas ballast

Gas ballast is a continuous purge to keep the pump's interior as clean as possible and to reduce the possibility of condensation inside the pump.

⚠ DANGER

➡ Air and pumped media might react inside the pump or at the outlet of the pump and form hazardous or explosive mixtures, when you use air rather than inert gas for the gas ballast. This constitutes a risk of significant damage to equipment and/or facilities, a risk of personal injury or even loss of life.

⚠ WARNING

☞ Make sure that air/gas intake through the gas ballast valve can never lead to hazardous, explosive or otherwise dangerous mixtures. If in doubt, use inert gas.

NOTICE

To reduce condensation in the pump, do not pump vapor before the pump has reached its operating temperature. Open the gas ballast valve when pumping condensable vapors. Turn gas ballast cap to open valve.

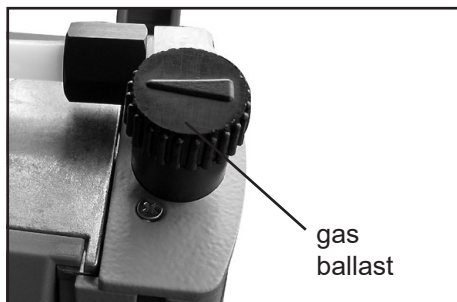

For **condensable vapors** (water vapor, solvents, etc.):

- The gas ballast valve is open if the arrow on the gas ballast cap is pointing towards the pump.
- With gas ballast valve open, the ultimate vacuum will be reduced.
- Use inert gas for gas ballast to avoid the formation of explosive mixtures. **Attention:** maximum supply pressure of inert gas: 17.5 psi (1.2 bar) absolute.
- Close the gas ballast valve by turning the cap 180°.

In case of low boiling solvents (when the formation of condensate is unlikely), the use of gas ballast might be unnecessary. Operating the pump without gas ballast increases the solvent recovery rate at the exhaust waste vapor condenser.

Important notes concerning the operation of the exhaust waste vapor condenser

! DANGER

- ➔ Connect the exhaust to a suitable treatment system to prevent the discharge of dangerous gases and vapors to the surrounding atmosphere.

! WARNING

- ☞ Never block the gas outlet ((6) hose nozzle for tubing I.D. 3/8" (10 mm)). The exhaust hose must always be unobstructed and without back-pressure to enable an unhindered discharge of gases.
- ☞ Check the overpressure safety relief device (17) at the exhaust waste vapor condenser (9) regularly; replace if necessary. Check especially for deterioration, coalescence and cracks.

CAUTION

- Ensure that the **coolant outlet hose** is always free and that it cannot get blocked.
- Maximum permissible coolant pressure at the exhaust waste vapor condenser: 87 psi (6 bar) absolute
- Comply with the maximum permissible coolant pressures of additional components in the coolant circuit (e.g., coolant valve).
- We strongly recommend installing an optional coolant valve (see „Accessories“, pg. 98) **in the supply line** of the exhaust vapor condenser to save water and reduce the risk of water spill.
- Avoid overpressure in the coolant circuit (e.g., caused by blocked or kinked coolant hoses).
- Avoid any clogging of the exhaust vapor condenser caused by deposits or frozen solvents. Clean if necessary or use higher coolant temperatures.

NOTICE

In case of **condensation**: Check the liquid level in both catchpots (10) during operation. Check the liquid level regularly. Do not allow the catchpots to overflow. Drain catchpots in time to avoid overflow. Install a level sensor (see „Accessories“, pg. 98) for monitoring, if necessary. The maximum liquid level is at approximately 80% of the total filling level to avoid problems when removing the catchpots.

Permissible range of coolant temperature at the exhaust waste vapor condenser:

5 °F to 68 °F (-15°C to +20°C)

Check hose connections prior to starting operation of the cooling system.

Check coolant hoses regularly during operation.

Removing the catchpots:

Stop process.

Catchpot at outlet:

Remove joint clip. Remove catchpot and drain condensate.

Catchpot at inlet:

Admit air or inert gas (via the pump inlet) to restore atmospheric pressure in the catchpot before attempting removal. Remove joint clip. Remove catchpot and drain condensate.

NOTICE

Reattach drained catchpots.

WARNING

☞ **Important:** Comply with regulations when disposing of solvents/condensates. Recycle if possible; purify if contaminated.

Shutdown & storage

The pump can be switched off under vacuum.

NOTICE

Short-term:

Has the pump been exposed to condensate?

- Allow the pump to continue to run at atmospheric pressure for a few minutes.

Has the pump been exposed to media which may damage the pump materials or form **deposits**?

- Check and clean pump heads if necessary.

Has the pressure transducer been exposed to media which may form deposits?

- Clean pressure transducer at the CVC 3000 controller if necessary.

Long-term:

- Take measures as described above regarding short-term shutdown.
- Separate the pump from the application.
- Close inlet and outlet ports (e.g., with transport caps).
- Close the gas ballast valve.
- Drain catchpots.
- Store the pump under dry conditions.

CVC 3000 Vacuum controller

When switching on the CVC 3000 controller for the very first time, a menu to select the language of the controller menu is displayed. Select the desired language, e.g., "English" by turning the selection knob and pressing to confirm. Then select the pressure unit ("mbar", "Torr" or "hPa") in the same way.

It is possible to access the language selection menu at any time by switching on the controller while keeping the selection knob pressed.

After switching on the device, the **version number of the software** is displayed, followed by the preselected function and the pressure reading.

Attention: Do not assemble or remove plug connections off-axis! Orient the plug correctly before inserting. To connect additional components use VACUU•BUS Y-adapters and extension cables. If an external pressure transducer is connected, it is recognized automatically. Further information on how to use several sensors simultaneously is available upon request.

Keys

VENT:

- A short tap vents momentarily; process continues.
- Pressing longer than 2 seconds vents the system to atmospheric pressure (to 788 Torr (1050 mbar) at maximum); process stops.

MODE:

- Selects menu "function"
- Use for temporary switching during operation to other functions

Start or Stop the process

ON/OFF switch

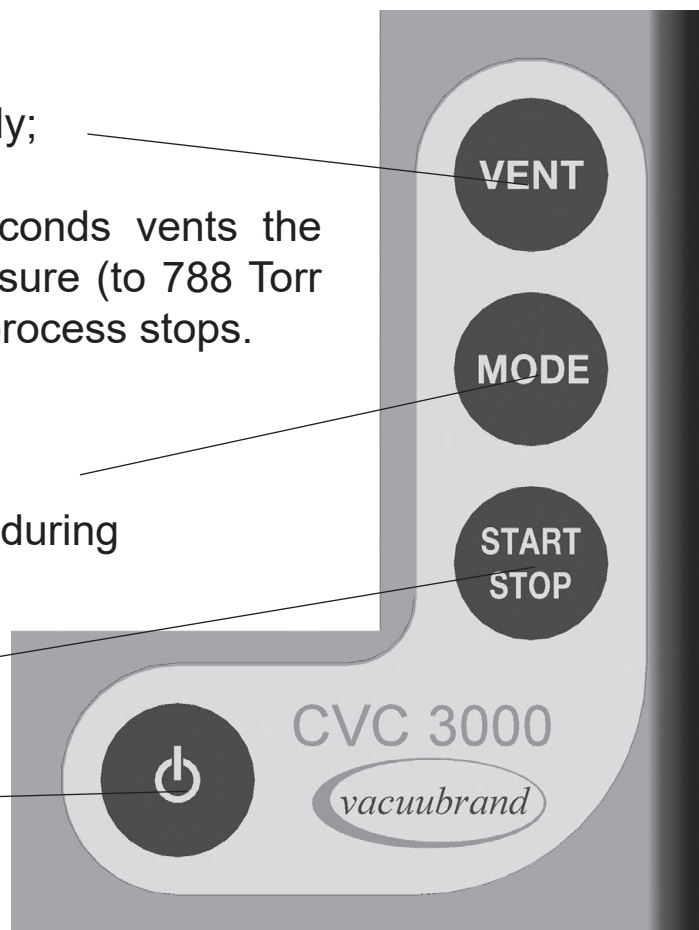

Selection knob

- Press to reach the set-up menu of the function
- Turn to choose the parameter you want to modify
- Press to select the parameter you want to modify
- Turn to change the set value of the parameter
- Press to confirm change of value and to reach further parameters, or to leave the set-up menu

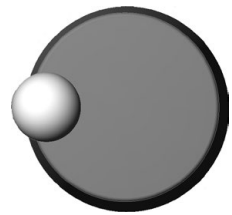

Display and symbols

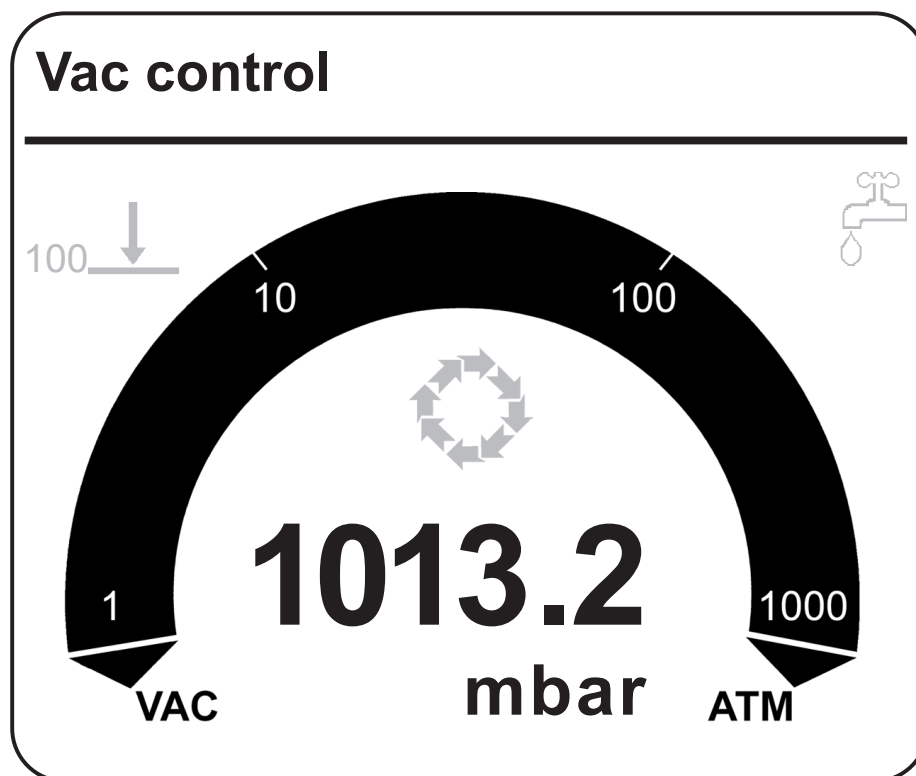

Selected function (displayed in the upper left corner):

















A "function" is one of the following operation modes of the CVC 3000 controller:

Pump down / Vac control / Auto mode (only with VACUU•BUS-compatible VARIO pump) / Program / VACUULAN / Configuration

Other display symbols:

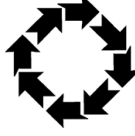
1013.2 Actual absolute pressure at the pressure transducer

mbar / Torr / hPa Preselected pressure unit

100  / 100 	Vacuum control to a preset vacuum value (here: 100 mbar/Torr/hPa); (without / with VACUU•BUS-compatible VARIO pump)
 / 	Actual pressure is in the range "Set vacuum + hysteresis" (without VACUU•BUS-compatible VARIO pump) / Actual pressure = "Set vacuum" (with VACUU•BUS-compatible VARIO pump)
	Flashing: The actual pressure is greater than the preset maximum value (" <i>Maximum</i> ")
	Minimum value (" <i>Minimum</i> ") reached
00:00:00	Process runtime (only if process control is running)
	Pump down (continuous pumping)
50% 	Pump symbol is displayed when pump is running. With a VACUU•BUS-compatible VARIO pump, the pump's motor speed is also displayed in % of full speed.
5 	Time meter is running (in function "VACUULAN"); remaining time in minutes is displayed
	In-line valve switched on
	Venting valve switched on
	Coolant valve switched on
	PC symbol: controller is in remote operation
	Control is running
	Warning notice (if necessary in combination with other symbols), flashing
	Level sensor activated; catchpots need to be emptied.
	Peltronic emission condenser connected

Notes on selecting the function

The CVC 3000 controller can be adapted to the specific application by choosing the appropriate function depending on the connected components and the requirements of the application.

Automatic detection of the components

When switching on the controller, the configuration of the connected components is checked automatically.

Connected components (e.g., VACUU•BUS-compatible VARIO pumps, gauge heads 3000 series, valves, level sensors) are **detected automatically** and controlled by the CVC 3000 until the controller is switched off. Identical components must be configured beforehand; information upon request. Switch the controller off and on again to renew the configuration. The last mode of operation and the preselected values (e.g., for pressure, speed or time for automated switching off) are stored.

If the preselections are chosen appropriately, it is possible to start immediately if similar operating conditions are desired.

The controller features **five functions and one configuration menu**, see section "Menu guide". Each of these functions involves different menu options, which are presented automatically and reflect the connected components. **The types of components connected (e.g., valves) determine the active menu items.**

Changing the function:

- Switch controller on.
- Press "START/STOP" key to terminate control in case control is running (e.g., if "Autostart" is activated).
- Press "MODE" key.
- Select function with knob and press to confirm.

☞ Depending on the selected function and system components, the controller provides different operating control, as follows:

"Pump down"

- Manages the continuous speed control of the VACUU•BUS-compatible VARIO pump depending on preselected pressure and time settings.
- Coolant valve

”Vac control”

- With pressure preselection, controls a VACUU•BUS-compatible VARIO pump to maintain pinpoint control of that pressure.
- Coolant valve

”Auto mode”

- Provides fully automatic boiling point determination and adaptation with pinpoint precision, and optimization of pumping speed with VACUU•BUS-compatible VARIO pumps.
- Coolant valve

”Program”

- Control pump based on time and pressure preselections, or ”Auto mode”.
- Coolant valve
- Venting valve

”VACUULAN”

- Use continuous speed control to manage VACUU•BUS-compatible VARIO pumps, based on pressure and time preselections.
- Coolant valve

”Configuration”

Preselections for

- Adjustment of the pressure transducer
- Interface RS-232
- Sensors (configuration and switching between several sensors)
- Display (brightness and contrast of the display, language, sound)
- Autostart (automatic restart after power failure)
- Defaults (reset the controller to factory set values)

Menu guide

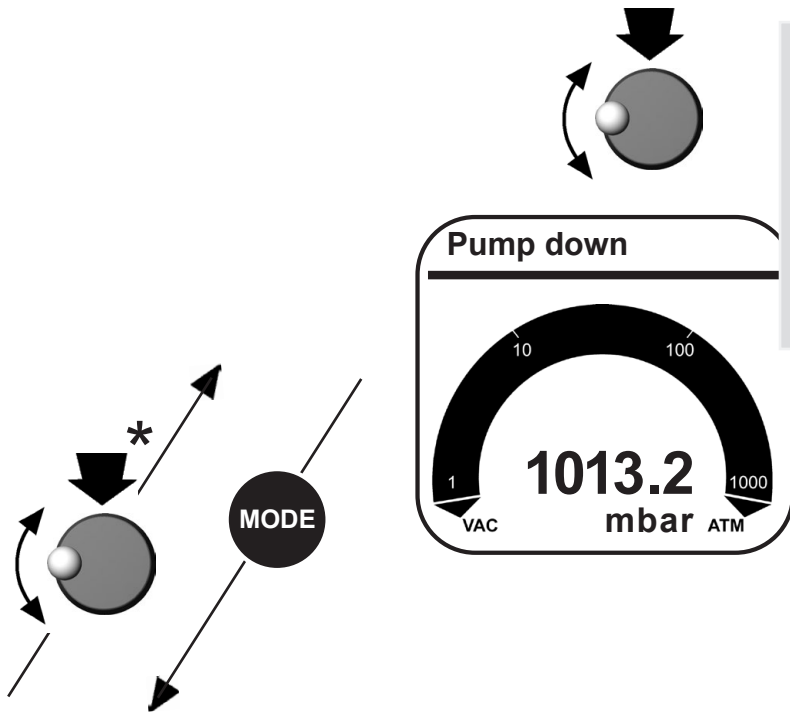

Pump down	
Speed	HI
Minimum	Off
Delay	Off
Duration	Off
----- Graphic -----	
----- Back -----	

Function
Pump down
Vac control
Auto mode
Program
VACUULAN
Configuration
----- Back -----

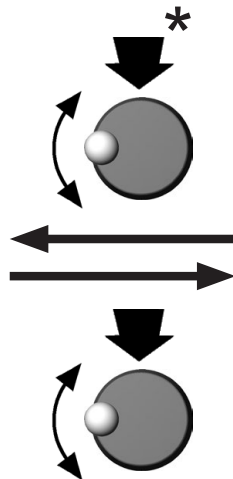

Configuration	
Adjustment	760 Torr
RS-232...	
Sensors...	
Display...	
Autostart	Off
Defaults	Cancel
----- Back -----	

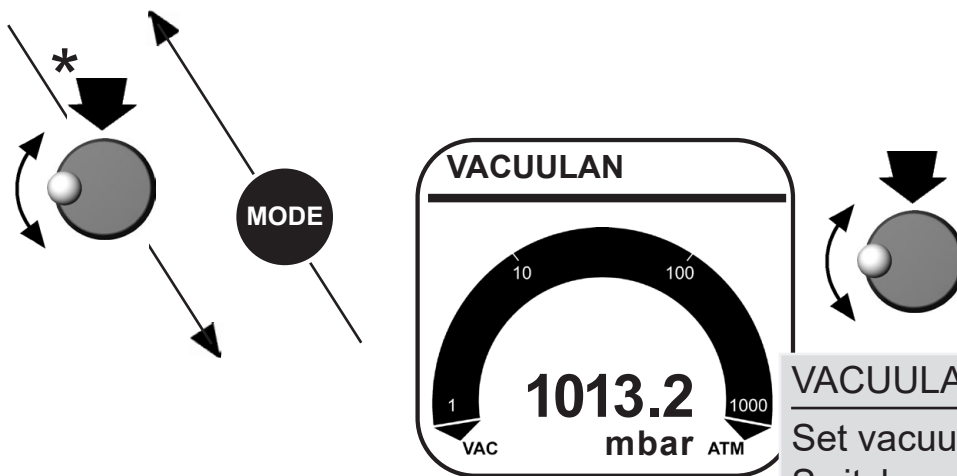

VACUULAN	
Set vacuum	19 Torr
Switch on	150 Torr
Delay	15 min
----- Graphic -----	
----- Back -----	

* : or automatically after 20 seconds without action

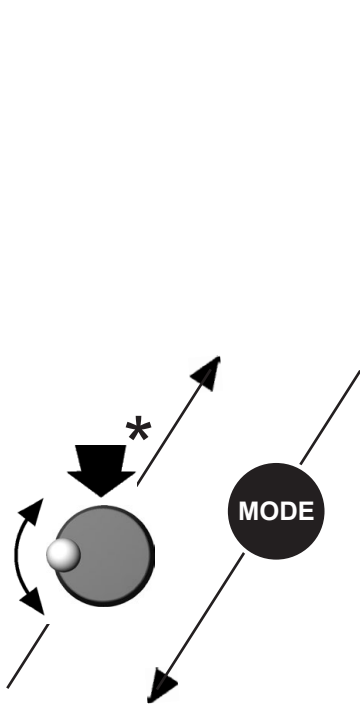

Vac control

Vac control	
Set vacuum	75 Torr
Speed	HI
Maximum	Off
Delay	Off
Duration	Off
----- Graphic -----	
----- Back -----	

Function
Pump down
Vac control
Auto mode
Program
VACUULAN
Configuration
----- Back -----

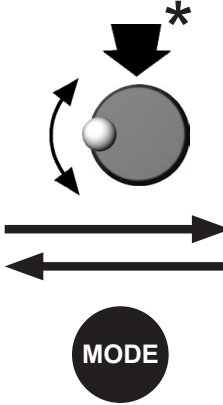

Auto mode

Auto mode	
Sensitivity	normal
Speed	HI
Minimum	Off
Delay	Off
Duration	Off
----- Graphic -----	
----- Back -----	

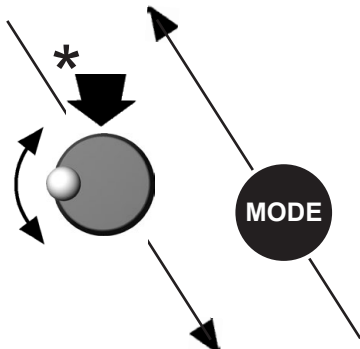

Program

Program	
Edit	
Open	0
Store	0
Delay	Off
----- Graphic -----	
----- Back -----	

* : or automatically after 20 seconds without action

Pump down function

Function definition:

➔ **Continuous pumping with pressure and time settings**

- **Operation on demand of a speed controlled VACUU•BUS-compatible VARIO pump**

Preselections

☞ Use the selection knob to select the parameters. All parameters can be altered even while operation control is running.

☞ **Speed:** Preselection of the motor speed for pump down. The selection "HI" effects the maximum speed and best ultimate vacuum of the pump (with automatic speed reduction at ultimate vacuum). The "Speed" is adjustable in a range of 1-100% and to "HI".

☞ **Minimum:** The controller switches the pump off once the preset value for "Minimum" has been reached.

"Minimum" is adjustable in a range of 1-795 Torr (1-1060 mbar) or can be set to "Off".

A preset "Duration" (process time) has no effect if the process is stopped due to a preset "Minimum" before "Duration" is reached.

☞ **Delay:** "Delay" determines the time the coolant valve remains open after the process has been stopped.

The "Delay" is adjustable in a range of 1-300 minutes or can be set to "Off" ("Off" means that the coolant valve closes immediately when the process stops.).

☞ **Duration:** "Duration" determines the total process time since control start.

The process time is adjustable between 1-1440 minutes (24 h) or can be set to "Off". "Off" indicates that no endpoint for pump down is determined.

If a "Duration" is preset, the controller switches off the pump when the preset process time is reached, even if a preset "Minimum" is still not reached.

- ☞ If neither "*Minimum*" nor "*Duration*" is preset, process control has to be stopped by pressing key "STOP".

The screen-shot shows the factory-set values.

Pump down	760 Torr
Speed	HI
Minimum	Off
Delay	Off
Duration	Off
----- Graphic -----	
----- Back -----	

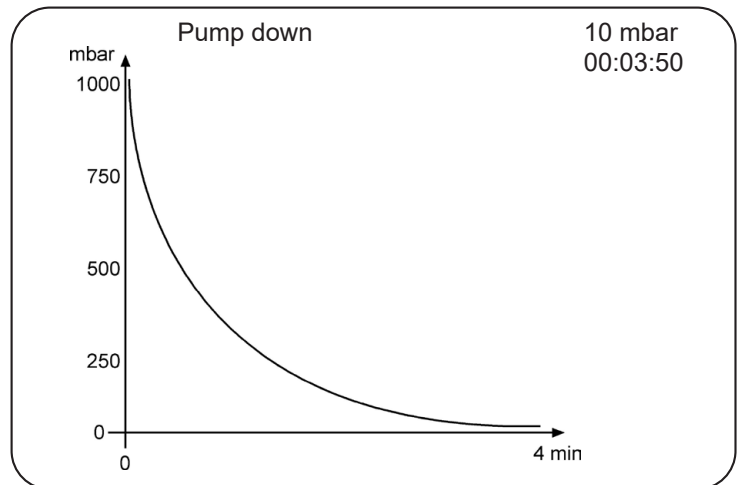

When selecting "*Graphic*" the display shows a pressure vs. time curve.

The timeline in the diagram adapts automatically to the process time.

- ☞ Press the selection knob twice to return to the standard display.

Temporary switching from "Pump down" to "Vac control" or "Auto mode" (only if control is running):

- ☞ Press "MODE" key. The controller switches to "Vac control" function, the current vacuum is used as set value.
- ☞ Pressing "MODE" key again switches to "Auto mode" function. The controller adapts the boiling pressure starting from the current vacuum level.
- ☞ The preset function of the controller does not change due to this temporary switching. When pressing "STOP" key, the controller is set again to the "Pump down" function.

Adapting the pumping speed during pump down:

- ☞ Press the selection knob and turn.
- ☞ Turning the knob to the left reduces the speed.
- ☞ Turning the knob to the right increases the speed.

Vac Control function

Function definition:

➔ **Vacuum control to a preset vacuum value**

- **Operation on demand of a speed controlled pump (VACUU•BUS-compatible VARIO pump)**

Preselections

☞ Use the selection knob to select the parameters. All parameters can be altered even while operation control is running.

☞ **Set vacuum:** The "Set vacuum" is the set point for vacuum control with pinpoint precision for VACUU•BUS-compatible VARIO pumps. The "Set vacuum" is adjustable in a range of 1-795 Torr (1-1060 mbar) or can be set to "Turbo". The selection "Turbo" leads to the optimum backing pressure for a turbomolecular pump.

☞ **Speed:** The maximum motor speed can be preselected (to control the pumping speed). The "Speed" is adjustable in a range of 1-100% or can be set to "HI". The selection "HI" (recommended) provides the optimum pumping speed of the pump and therefore an optimum ultimate vacuum.

☞ **Maximum:** An upper pressure limit can be preselected. The pump switches off if the pressure limit is exceeded, e.g., at the end of suction or filtrations. The pressure limit is only active once the pressure has gone below "Maximum". The "Maximum" is adjustable in a range of 794-1Torr (1059 - 1 mbar) (at the least 1 Torr (mbar) higher than the "Set vacuum") and to "Off". "Off" means that no "Maximum" value is preset.

☞ **Delay:** "Delay" determines the time the coolant valve remains open after the process has been stopped. The "Delay" is adjustable in a range of 1-300 minutes or can be set to "Off" ("Off" means that the coolant valve closes immediately when the process stops.).

☞ **Duration:** "Duration" determines the total process time since control start.

A preset "*Duration*" (process time) has no effect if the process is stopped due to a preset "*Maximum*" before "*Duration*" is reached. The "*Duration*" is adjustable between 1-1440 minutes (24 h) or can be set to "Off". "Off" means that no endpoint of the process is defined.

The screen-shots show the factory-set values.

Vac control	760 Torr
Set vacuum	75 Torr
Speed	HI
Maximum	Off
Delay	Off
Duration	Off
----- Graphic -----	
----- Back -----	

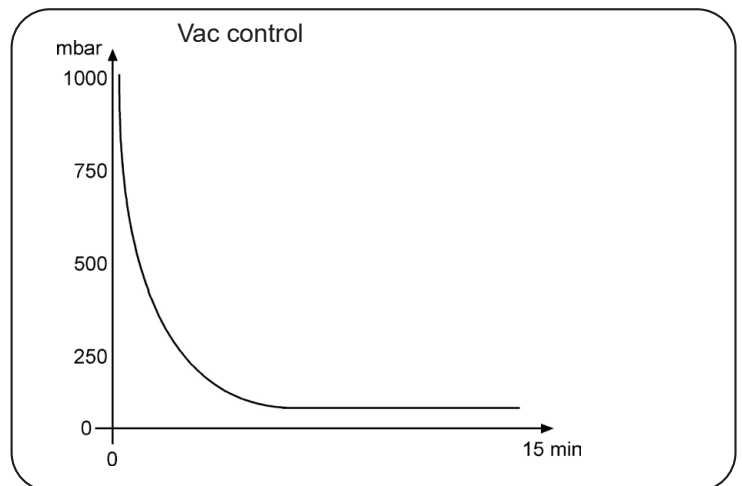

When selecting "*Graphic*" the display shows a pressure vs. time curve.

The timeline in the diagram adapts automatically to the process time.

☞ Press the selection knob twice to return to the standard display.

Temporarily switching from "*Vac control*" to "*Auto mode*" while process control is running:

☞ Press "MODE" key. The controller switches to "Auto mode" and adapts the boiling pressure starting with the actual set value. The preset function of the controller does not change due to this switching. When pressing the "STOP" key, the controller is in "Vac control" function again.

Adjustment of the set vacuum during vacuum control:

Dynamic, interactive adaptation:

- ☞ Press the selection knob and keep pressed.
- ☞ Turning the knob for a 1/4 turn to the left causes pump down.
- ☞ Turning the knob for a 1/4 turn to the right causes venting.
- ☞ When the knob is released, the current pressure value is used as new set value.

Alternatively:

Fine tuning:

The set vacuum can be fine-adjusted by turning the selection knob while process is running.

- ☞ Turn the selection knob.
- ☞ A full turn causes a change of the set vacuum of 9 Torr (12 mbar).
- ☞ Turning the knob one detent causes a change of the set vacuum of 1 Torr (mbar).

Auto mode

Function definition:

➔ **Control of a VACUU•BUS-compatible VARIO pump in "Auto mode":**

Automatic detection of boiling points, and automatic adjustment of determined boiling points as process parameters change.

Preselections

☞ Use the selection knob to set the parameters.

☞ **Sensitivity:** The "*Sensitivity*" of the control determines the control speed. The "*Sensitivity*" is adjustable to "high", "normal" or "low".

High sensitivity leads to a reduced pump-down speed, e.g., for small amounts of solvents or foaming processes. Use a low sensitivity for "non-critical" processes to reduce process time. Usually setting the "*Sensitivity*" to "normal" is appropriate.

☞ **Speed:** The maximum motor speed can be preselected (to limit the pumping speed).

The "*Speed*" is adjustable in a range of 1-100% or can be set to "HI". The selection "HI" (recommended) causes an automatic limitation of the adaptation depending on parameters determined during the process. Only in case of very sensitive processes is it advisable to reduce the maximum speed.

☞ **Minimum:** If the vacuum value reaches "*Minimum*" the process is stopped. Use "*Minimum*" for automatic process termination.

The "*Minimum*" is adjustable in a range of 2-795 Torr (2 - 1060 mbar), or can be set to "Auto" or to "Off".

When selecting "Auto" the controller switches off automatically at the end of the process (boiling plateau). This is recommended only for large amounts of solvents.

☞ **Delay:** "*Delay*" specifies the time the coolant valve remains open after process stop.

The "*Delay*" is adjustable in a range of 1-300 minutes or can be set to "Off" ("Off" means that the coolant valve closes immediately when the process stops.).

☞ **Duration:** "Duration" determines the total process time since control start.

The "Duration" is adjustable between 1-1440 minutes (24 h) or can be set to "Off". A preset "Duration" (process time) has no effect, if the process is stopped earlier by reaching the preset "Minimum".

The screen-shot shows the factory-set values.

Auto mode	760 Torr
Sensitivity	normal
Speed	HI
Minimum	Off
Delay	Off
Duration	Off
----- Graphic -----	
----- Back -----	

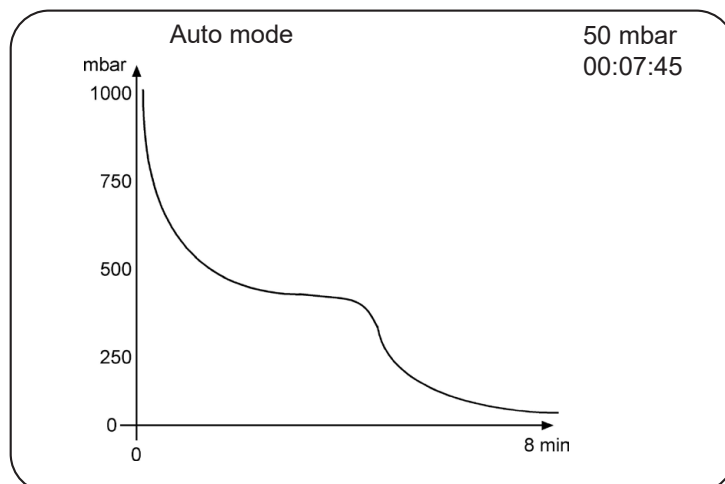

When selecting "Graphic" the display shows a pressure vs. time curve.

The timeline in the diagram adapts automatically to the process time.

☞ Press the selection knob twice to return to the standard display.

Temporary switching from "Auto mode" to "Vac control" function

☞ Press "MODE" key. The controller switches to "Vac control". The current pressure value is used and held as new set point.

☞ The preset function of the controller does not change due to this temporary switching. When pressing "STOP" key, the controller is set again to the "Auto mode".

Program function

Function definition:

➤ **Permits ten programs to be defined and stored, each with up to ten program steps with preset values for vacuum and time.**

👉 **Edit:**

Use to define the preset values for the process run:

Time: Defines either the process runtime for each program step to reach a preset vacuum level or, if programming a "Step", the runtime after having achieved the vacuum level. The total process runtime is shown in the base line. Attention: A preset runtime of 99:59:59 hours in the final program step will cause the process to run endlessly. Terminate the process by pressing the "STOP" key .

Vacuum: Vacuum level to be attained.

Venting valve: Operating a venting valve to reach a preset vacuum level.

"Step": "Step" causes pump down as fast as possible to the preset vacuum level. As soon as the vacuum level is reached the time meter starts running.

"Auto": Auto = \downarrow : indicates that the system will search for a boiling point automatically, and will automatically adapt to changes in the boiling point until a preselected time interval expires.

Auto = \rightarrow : indicates that the system will automatically adapt to changes in the boiling point. The program step is finished when the selected time or pressure value has been reached.

Selecting "Auto" in combination with "Step" in one program step is not possible.

👉 **Open:** Choose program (Programs 0 - 9).

👉 **Store:** This command stores an edited program or the program of the last process to one of the storage spaces 0 - 9.

👉 **Delay:** "*Delay*" specifies the time the coolant valve remains open after process stop.

The "*Delay*" is adjustable in a range of 1-300 minutes or can be set to "Off" ("Off" means that the coolant valve closes immediately when the process stops.).

Editing:

- ☞ To select row: turn and press selection knob.
- ☞ To adjust parameter: turn the selection knob.
- ☞ To confirm parameter: Press selection knob. Controller will accept change and jump to the next parameter in the same row.
- ☞ After 5 seconds without a change, the parameter is assumed to be the current setting. Select the next row to edit or return to the Program menu.
- ➡ In case, store an edited program after having quit "Edit" by storing it to one of the storage spaces 0 - 9 (select "Store").

The screen-shot shows the factory-set values.

Program	760 Torr
Edit	
Open	0
Store	0
Delay	Off
----- Graphic -----	
----- Back -----	

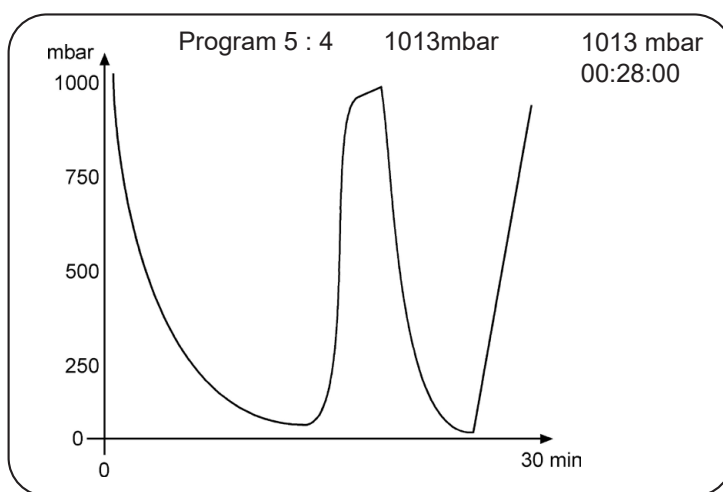

When selecting "Graphic", the display shows a pressure vs. time curve.

Program number, and the step number in that program, along with the vacuum setting, the actual current pressure and the actual runtime are displayed across the top.

The timeline in the diagram adapts automatically to the process time.

- ☞ Press the selection knob twice to return to the standard display.

The most recent process (except in "VACUULAN" function) is stored in the temporary data memory as long as the controller stays switched on. This program can be transferred to a storage space and edited.

Once the program is finished, the clock symbol starts to flash. Confirm the end of the program by pressing START/STOP (clock symbol will disappear).

Attention: If "**Autostart**" is set to "**On**", the **program will start again (time will be reset to 00:00:00) after a power failure or after switching the controller off/on**. Only if the end of the program (clock symbol flashing) has been confirmed by pressing START/STOP, the program will not start again.

Attention: If the controller is set to "Defaults": "On", all stored programs will be deleted.

Application example

Example

VACUU•BUS-compatible VARIO vacuum pump with speed control (e.g., with a rotary evaporator): Degassing and automatic distillation with timing

Program					
No	hh:mm:ss	Vac	Vent.	Step	Auto
01	00:00:00	ATM	✓	✓	
02	00:10:00	300		✓	
03	01:00:00	2			↓*
04	00:01:00	ATM	✓	✓	
05	00:00:00	0			
06	00:00:00	0			
07	00:00:00	0			
08	00:00:00	0			
09	00:00:00	0			
10	00:00:00	0			
----- Back -----					
01:11:00					

* If the pressure difference between the vacuum for degassing and the expected vacuum for distillation is very small (distillation vacuum >75% of the degassing vacuum), select the function "Auto →" (adapting the vacuum starting from the current pressure) instead of "Auto ↓" (at first searching the boiling point automatically, and then adapting the vacuum).

Program step 1 should be always a definite initial state, here atmospheric pressure (ATM). To reach this state definitely, set a tickmark at "Vent." and "Step" by pressing the selection knob.

In step 2, pumping begins, attempting to reach 300 Torr/mbar as quickly as possible ("Step"). Vacuum holds there for 10 minutes (degassing the solvent).

In step 3, "Auto ↓" causes an automatic search of a boiling point in the pressure interval between 300 Torr/mbar/hPa (depending on preset pressure unit) and 2 Torr/mbar/hPa, followed by automatic adaptation to changes in the boiling point. The following step starts either (1) once the cumulative process time reaches the set limit (1 hour/60 minutes), even if the preset pressure (2 Torr/mbar/hPa) has not been reached, or (2) if a vacuum of 2 Torr/mbar/hPa is reached, even if the preset time has not been completed.

Step 4 vents to atmospheric pressure as fast as possible and switches off the control after one minute.

VACUULAN function

Function definition:

- ➔ **Optimizes vacuum control for vacuum networks (e.g., VACUUBRAND VACUU•LAN)**
- ➔ **Permits on-demand operation of a speed-controlled pump (VACUU•BUS-compatible VARIO pump)**

Preselections

- 👉 Use the selection knob to select the parameters.
- 👉 **Set vacuum** (the lower switch-off value): If the pressure drops below the "Set vacuum", a time-meter starts to run and the motor speed is reduced. When the pressure exceeds the "Set vacuum" pressure again, the time meter is reset. If the "Set vacuum" is not reached within 100 hours, the controller signals an error.
The "Set vacuum" is adjustable in the range of 1-795 Torr (1-1060 mbar).
- 👉 **Switch on** (the higher switching value): If the pressure exceeds this pressure, pumping down starts again.
The "Switch on" pressure is adjustable in the range of 2-795 Torr (2-1060 mbar).
In the event of a sudden high-pressure spike, pumping starts again even if the "Switch on" pressure has not been reached (pressure increase control).
- 👉 **Delay**: If the vacuum is below "Set vacuum" for longer than the "Delay" time, the pump is stopped. Pumping starts again in the event of a rapid pressure increase or if the "Switch on" level is exceeded.
The "Delay" is adjustable in a range of 1-300 minutes or can be set to "Off" ("Off" means that the pump stops immediately when the pressure drops below "Set vacuum".).

This screen-shot shows the factory-set values.

VACUULAN	760 Torr
Set vacuum	19 Torr
Switch on	150 Torr
Delay	15 min
----- Graphic -----	
----- Back -----	

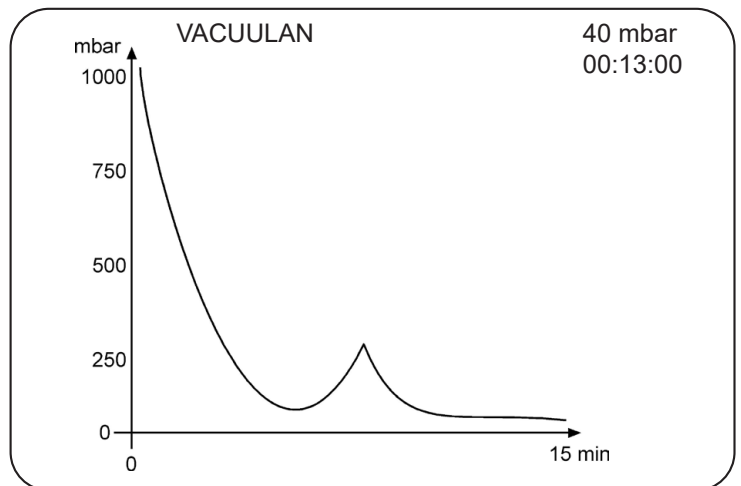

When selecting "*Graphic*" the display shows a pressure vs. time curve.

The timeline in the diagram adapts automatically to the process time.

☞ Press the selection knob twice to return to the standard display.

Application examples

Assembly of a vacuum system

- ☞ Assemble the vacuum connection line between the vacuum pump and the vacuum application.
- ☞ Assemble the vacuum connection line between the controller and the vacuum application, if the controller is not part of a pumping unit.
- ☞ Assemble electrical connections.
- ☞ Connect coolant if necessary.

Vacuum for filtration and suction

- ☞ Select "**Pump down**" function.
- ☞ If necessary, set value for "*Speed*" (high or low pumping speed). Reduce the speed in case of fast sedimentation (formation of a filter cake).
- ☞ Set "*Minimum*" to a value which provides adequate suction but does not lead to evaporation of the solvent.
- ☞ Start process by pressing "START/STOP" key.

alternatively:

- ☞ Select "**Vac control**" function.
 - ☞ Set "*Set vacuum*" to a value which does not lead to evaporation of the solvent.
 - ☞ If necessary, set value for "*Speed*" (high or low pumping speed). Reduce the speed in case of fast sedimentation (formation of a filter cake).
 - ☞ Set "*Maximum*" pressure setting so that pump will switch off at the end of the filtration process, or in the event that a filter cake cracks, leading to a sudden pressure increase.
 - ☞ Start process by pressing "START/STOP" key.
-
- ☞ **Tip for filtration:** Adjust preset pressure to a value well above the boiling pressure of the solvent (e.g., for water >>15 Torr (20 mbar)). Set the maximum pressure to e.g., 375 Torr (500 mbar). Once the filtration has finished, the pressure increases and the pump is switched off automatically.

Vacuum for gel dryer, drying chambers and vacuum concentrators

- ☞ Select function "**Pump down**" function. "*Speed*" "HI" is recommended. For gel dryers set a lower speed if necessary (if the gels tend to crack).
- ☞ Set "*Minimum*" to prevent volatile components from evaporating. The process is stopped automatically as soon as "*Minimum*" is reached.
- ☞ Set a process time ("*Duration*") if necessary.
- ☞ Start process by pressing "START/STOP" key.

alternatively:

- ☞ Select "**Vac control**" function to dry at a predetermined vacuum level.
- ☞ Set "*Set vacuum*" to the preferred evaporation vacuum of the solvent.
- ☞ Set a process time ("*Duration*") if necessary.
- ☞ Start process by pressing "START/STOP" key.

Vacuum for distillation and evaporation (e.g., rotary evaporator)

Fully automatic determination and adaptation of the boiling point with a VACUU•BUS-compatible VARIO pump (recommended)

- ☞ Select "**Auto mode**".
- ☞ Start process by pressing "START/STOP" key.
- ☞ The "Auto mode" allows a fully automatic distillation even if the boiling vacuum is unknown. With solvent mixtures, the vacuum is reduced until all solvents or volatile components are evaporated (with respect to the ultimate vacuum of the pump and the bath temperature).
- ☞ If "*Minimum*" is set, the controller switches off the pump when the pre-set vacuum value is reached. The "*Minimum*" should be well below the boiling vacuum of the solvent to be evaporated and above the ultimate vacuum attainable in the apparatus. If the "*Minimum*" is set to "Auto", the controller automatically switches off the pump at the end of the evaporation (recommended for large solvent quantities only). The setting of "*Duration*" (process runtime) has no effect if the pump is switched off due to "*Minimum*" before "*Duration*" is over.

- ☞ When setting a value for "*Duration*" the controller switches off the pump when "*Duration*" has passed even if a preset "*Minimum*" is still not reached.
- ☞ If neither "*Minimum*" nor "*Duration*" is preset, pumping down has to be finished by pressing the "START/STOP" key.

alternatively:

Semi-automatic distillation and evaporation

- ☞ Select function "**Pump down**".
- ☞ Start process by pressing "START/STOP" key.
- ☞ Observe process. As soon as evaporation starts, press "MODE" key (switching to "Vac control"). The vacuum level is kept constant (at the boiling pressure). Fine tuning of the vacuum value is possible by turning the selection knob.
Pressing "MODE" key a second time switches to "Auto mode" causing the vacuum level to be automatically adapted to changes of the boiling pressure.

alternatively:

- ☞ Select "**Vac control**" function.
- ☞ Set a maximum "Speed", to select a faster or slower process.
- ☞ To set "Maximum" is usually not necessary, unlike filtrations, because the pressure does not increase at the end of the evaporation.
- ☞ Set a value for "*Duration*" if the process should be terminated automatically after a definite time.
- ☞ Set "*Set vacuum*" depending on the solvent and the temperature.
- ☞ Start process by pressing "START" key.
- ☞ **To temporarily switch to "Auto mode"**: Press "MODE" key. The controller switches to "Auto mode". The setting of the controller does not change due to this switching. After pressing "START/STOP" key the controller is in "Vac control" again.

Vacuum for VACUU•LAN networks

- ☞ Select function "**VACUULAN**".
- ☞ Set "*Set vacuum*" to a pressure which can be reached reliably in the vacuum network. Take account of the ultimate vacuum of the pump and of the system's leak rate in case of no vacuum demand.
- ☞ Set "*Switch on*" pressure appropriately to ensure sufficient vacuum for all connected applications.
- ☞ Set "*Delay*" if necessary.
- ☞ Start process by pressing "START/STOP" key.

Configuration

In the "Configuration" menu the device parameters are preselected. After 20 seconds without action the function "Configuration" and its sub-menus (except submenu "Sensors") are quit automatically without storing any possibly changed parameter.

Preselections

- ☞ Use the selection knob to select the parameters.
- ☞ **Adjustment:** Adjustment of the pressure transducer under vacuum and/or at atmospheric pressure, see also section „Readjustment of CVC 3000“, pg. 84.
Adjustment to atmospheric pressure is carried out at an absolute pressure value between 795 - 525 Torr (1060 - 700 mbar). This is especially helpful in high elevation laboratories. Adjustment under vacuum may be done at an absolute vacuum value between 0 - 15 Torr (0 - 20 mbar). In the range between 15 to 525 Torr (20 to 700 mbar) no adjustment is possible; ---- Torr is displayed.
- ☞ **RS-232:** Configuration of the interface, setting of parameters and commands, see section "Interface".
Baud rate can be set to 19200, 9600, 4800 or 2400, parity on "8-N-1", "7-O-1" or "7-E-1", Handshake on "no", "Xon-Xoff" or "RTS-CTS" and remote on "On" or "Off".
- ☞ **Sensors:** Selection of the pressure transducer to be controlled (maximum 4 external sensors).
- ☞ **Display:** Selection of the device parameters "*Brightness*" between 0 - 100%, "*Contrast*" between 0 - 100%, "*Sound*" "On" or "Off", "*Units*" "mbar", "hPa" or "Torr", "*Language*" "German", "English", "French", "Italian", "Spanish", "Turkish", "Korean", "Chinese", "Portuguese", "Russian", "Polish", "Dutch", "Japanese", "Finnish".
- ☞ **Autostart:** If "*Autostart*" is set to "On" the controller restarts a running process automatically after a power failure. If this is unwanted, set "*Autostart*" to "Off".



Attention: If "*Autostart*" is preselected, the process starts immediately after power failure without pressing any further key. It is the user's responsibility to ensure that no dangerous status of the system due to the automatic start-up can occur and to provide appropriate safety measures. If necessary, the user has to check **prior to starting the process** if the option "*Autostart*" is enabled.

 **Defaults:** If "*Defaults*" is set to "Load", the controller is reset to factory set values. All stored programs and parameters are deleted.

This screen-shot shows the factory-set values.

Configuration	
Adjustment	760 Torr
RS-232...	
Sensors...	
Display...	
Autostart	Off
Defaults	Cancel
----- Back -----	

Please continue with part 2 of this manual.

Please continue with part 2 of this manual.