

VACUUM PUMP

VACUU·PURE 10C



Instructions for use



Original instructions Keep for further use!

This manual is only to be used and distributed in its complete and original form. It is strictly the user's responsibility to carefully check the validity of this manual with respect to the product.

Manufacturer:

VACUUBRAND GMBH + CO KG
Alfred-Zippe-Str. 4
97877 Wertheim
GERMANY

Phone:

Head office +49 9342 808-0
Sales +49 9342 808-5550
Service +49 9342 808-5660

Fax: +49 9342 808-5555

Email: info@vacuubrand.com

Web: www.vacuubrand.com

*Thank you for purchasing this product from **VACUUBRAND GMBH + CO KG**. You have chosen a modern and technically high quality product.*

TABLE OF CONTENTS

1	Introduction	5
1.1	User information	5
1.2	About this document	6
1.2.1	Manual structure	6
1.2.2	Display conventions	7
1.2.3	Symbols and icons	8
1.2.4	Handling instructions (action steps)	9
1.2.5	Abbreviations	10
1.2.6	Term definitions	10
2	Safety information	13
2.1	Usage	13
2.1.1	Intended use	13
2.1.2	Improper use	14
2.1.3	Foreseeable misuse	14
2.2	Obligations	15
2.2.1	Operator obligations	15
2.2.2	Personnel obligations	15
2.3	Target group description	16
2.4	General safety information	17
2.4.1	Safety precautions	17
2.4.2	Protective clothing	17
2.4.3	Laboratory and working materials	18
2.4.4	Chemical compatibility of materials	18
2.4.5	Eliminate sources of danger	19
2.5	Motor protection	23
2.6	Disposal	23
3	Product description	24
3.1	VACUU·PURE 10C	26
3.2	Optional accessories	27
3.2.1	Vacuum pump accessories	27
3.2.2	VACUU·BUS accessories	29
3.2.3	Modbus RTU protocol	30
3.3	Application example	31
4	Installation and connection	32
4.1	Transport	32
4.2	Set up the vacuum pump	33
4.3	Connection	35
4.3.1	Vacuum connection (IN)	35
4.3.2	Outlet connection (OUT)	39
4.3.3	Electrical connection	43

5	Commissioning (operation)	44
5.1	Switch on	44
5.2	Operation	44
5.2.1	Operation	46
5.2.2	Regeneration mode	47
5.2.3	Autostart	48
5.3	Advanced operation	49
5.3.1	Display of software / hardware version	49
5.3.2	Restore factory settings	51
5.3.3	Remote operation via Modbus RTU	52
5.4	Connect / remove VACUU·BUS accessories	53
5.4.1	VACUU·BUS detection	54
5.4.2	Operation with VACUU·BUS accessories	55
5.5	Shutdown (switch off)	57
5.6	Storage	58
6	Error messages	59
6.1	Warning display	59
6.2	Error indication	60
6.3	Troubleshooting	61
6.3.1	Technical support	61
6.3.2	Error – Cause – Remedy	62
7	Cleaning and maintenance	69
7.1	Information on maintenance work	70
7.2	Cleaning	71
7.2.1	Clean the vacuum pump	71
7.2.2	Empty glass flask (accessories)	72
7.3	Rinse vacuum pump	73
7.4	Air inlet filter	76
7.5	Replace the device fuse	77
8	Appendix	78
8.1	Technical information	78
8.1.1	Technical data	78
8.1.2	Rating plates	82
8.1.3	Wetted materials	83
8.1.4	Use of chemicals	84
8.2	Ordering information	85
8.3	Service	87
8.4	Index	88
8.5	EC Declaration of conformity	90
8.6	UKCA Declaration of conformity	91
8.7	CU Certificate	92

1 Introduction

This manual is part of your product. The manual applies to all versions of the vacuum pump and is intended in particular for laboratory staff.

1.1 User information

Safety

Instructions for use
and safety

- Read this manual thoroughly and completely before using the product.
- Keep this manual in an easily accessible location.
- Correct use of the product is essential for safe operation. Comply with all safety information provided!
- In addition to this manual, adhere to the accident prevention regulations and industrial safety regulations applicable in the country of use.

General

General information

- For easier readability, the general term *vacuum pump* is used as an equivalent to and instead of the product name *Chemical Vacuum Pump VACUU·PURE 10C*.
- If passing the product on to a third party, also give them this manual.
- The illustrations in this manual are only intended to facilitate comprehension.
- We reserve the right to make technical changes in the course of continuous product improvement.

Copyright

Copyright © and
copyright law

The content of this manual is protected by copyright. Only copies for internal use are allowed, e.g., for professional training.

© VACUUBRAND GMBH + CO KG

Contact

Contact us

- If your manual is incomplete, you can request a replacement. Alternatively, you can use our download portal: www.vacuubrand.com
- You are welcome to contact us at any time in writing or by telephone if you would like more information, have questions about our products or wish to share feedback with us.
- When contacting our Service Department, please have the serial number and product type at hand → *see Rating plates on the product.*

1.2 About this document

1.2.1 Manual structure

Specific information

The manual has a modular structure with separate instruction modules for the vacuum pump and any accessories.

Instruction modules

Vacuum pump and modular instruction manuals

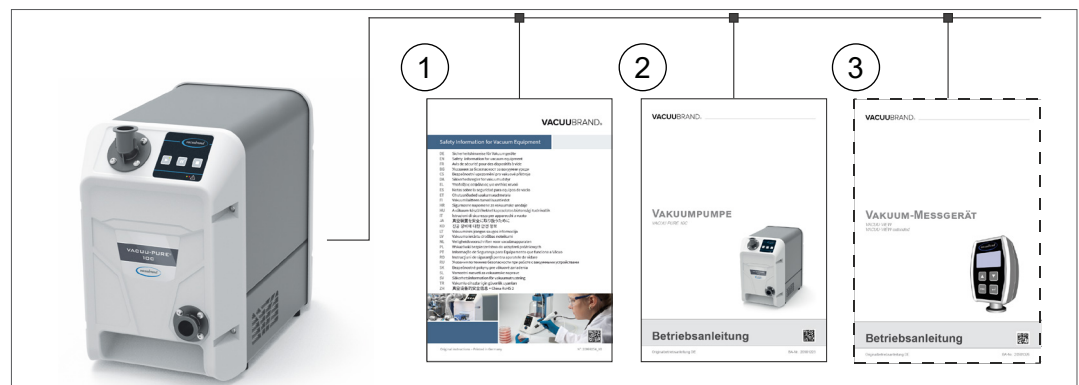

Description

- 1 Safety information for vacuum equipment
- 2 Description: Vacuum pump – connection, operation, service
- 3 Optional description: Accessories

1.2.2 Display conventions

Warning levels

Presentation
conventions

	DANGER
	<p>Indicates an imminent hazardous situation. Disregarding the situation could result in extremely serious injury or death.</p> <p>⇒ Take appropriate action to avoid dangerous situations!</p>

	WARNING
	<p>Warns of a potentially hazardous situation. Disregarding the situation could result in serious injury or death.</p> <p>⇒ Take appropriate action to avoid dangerous situations!</p>

	CAUTION
	<p>Indicates a potentially hazardous situation. Disregarding the situation could result in minor injury or damage to property.</p> <p>⇒ Take appropriate action to avoid dangerous situations!</p>

NOTE	
<p>Indicates a potentially harmful situation. Disregarding the situation could result in damage to property.</p>	

Additional notes

IMPORTANT!

- ⇒ Information or specific recommendation which must be observed.
- ⇒ Important information for trouble-free operation of your product.



- ⇒ Helpful tips + tricks
- ⇒ Additional information











1.2.3 Symbols and icons

This manual uses symbols and icons. Safety symbols indicate specific risks associated with handling the product. Symbols and icons are designed to help you identify risks more easily.

Safety symbols

Explanation of safety symbols		Hazardous substance – hazards to human health.		General prohibition sign.
		General warning symbol.		Warning: hot surface.
		Danger: electricity.		
		General mandatory sign.		Disconnect power plug.
		Wear chemical-resistant protective gloves.		Wear protective goggles.

Additional symbols and icons

Additional symbols		Positive example – Do this! Result – OK		Negative example – Don't do this!
		Press key		Keep key pressed
		Refers to content in this manual.		Refers to content in other supplementary documents.
			Electric/electronic devices must not be disposed of in domestic waste at the end of their service life.	
	Installation at temperatures < 40 °C.		Ensure sufficient air circulation.	

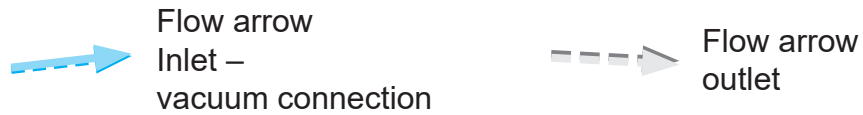

1.2.4 Handling instructions (action steps)

Instructions (single step)

Action steps as text ⇒ Perform the step described.

Result of action

Instructions (multiple steps)

1. First step
2. Next step

Result of action

Instructions (shown graphically)

Schematic diagram
Action steps as
graphics

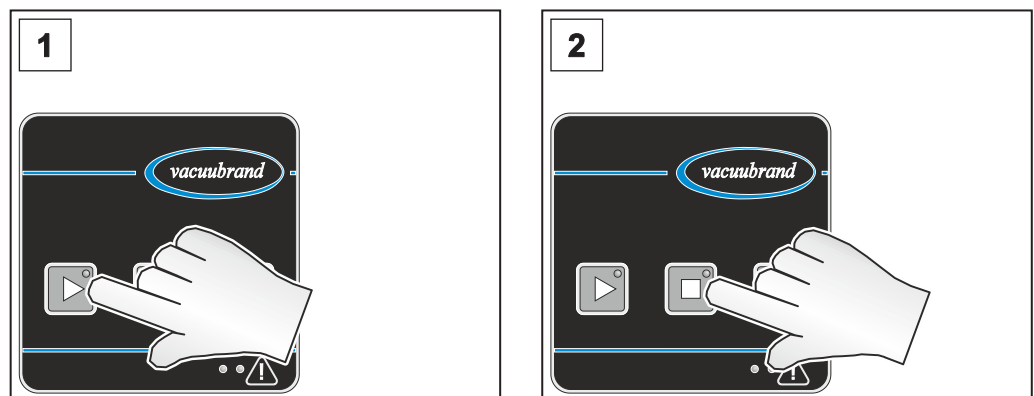

1. First step

2. Next step

Result of action

⇒ Perform the steps in the order described.

1.2.5 Abbreviations

Abbreviations

abs.	Absolute
AK	Separator
ATM	Atmospheric pressure
d_i (di)	Interior diameter
DN	Nominal diameter
EK	Vapor condenser
FKM	Fluoroelastomer
IN	Inlet, vacuum connection
KF	Small flange
max.	Maximum
min	Minutes
OUT	Outlet
PE	Polyethylene
PEEK	Polyetheretherketone
PP	Polypropylene
PPS	Polyphenylene sulfide
PTFE	Polytetrafluoroethylene
RMA no.	Return Merchandise Authorization number
RTU	Remote Terminal Unit
Resp.	Responsible

1.2.6 Term definitions

Product-specific terms

Separator	Glass flask/separator mounted at the inlet.
Autostart	When the power supply is switched off and then back on, the last active operating state of the vacuum pump is automatically reactivated.
Vapor condenser	Cooling condenser with receiving flask mounted at the outlet (pressure side).
Fine vacuum	Pressure range in vacuum technology, from: 1 mbar – 0.001 mbar (0.75 Torr – 0.00075 Torr)
Rough vacuum	Pressure range in vacuum technology, from: atmospheric pressure – 1 mbar (atmospheric pressure – 0.75 Torr)
Modbus RTU	Communication protocol for communication with the vacuum pump. ▶ See separate manual for description of the Modbus RTU.

Regeneration mode	Operating mode of the vacuum pump, when the pump unit is dried by ambient air sucked in at reduced pump speed.
Check valve (internal)	Internal valve for safe operation of the vacuum pump. No vacuum-tight switch-off when the vacuum pump stops.
Sealing gas	Ambient air drawn in by the vacuum pump to protect the drive side of the vacuum pump from pumped media.
VACUU·BUS	Bus system from VACUUBRAND for communication between peripheral devices and VACUU·BUS-enabled products.
VACUU·BUS address	Address which enables the VACUU·BUS client to be unambiguously assigned within the bus system, e.g., for connecting multiple sensors with the same measuring range.
VACUU·BUS client	Peripheral device or component with VACUU·BUS port, which is integrated in the bus system, e.g., sensors, valves, level indicators, etc.
VACUU·BUS configuration	Assigning a different VACUU·BUS address to a VACUU·BUS component using a gauge or controller.
VACUU·BUS connector	4-pin round connector for the bus system from VACUUBRAND .
VACUU·PURE shuttle	Mobile base frame for the vacuum pump, provides the necessary increased ground clearance when mounting the vapor condenser.
VACUU·VIEW extended	External vacuum sensor with VACUU·BUS port, 1100 – 0.001 mbar. ▶ for connection to the vacuum pump or with own plug-in power supply.

2 Safety information

The information in this chapter must be observed by everyone who works with the product described here.

The safety information is valid for the entire life cycle of the product.

2.1 Usage

Only use the product if it is in perfect working condition.

2.1.1 Intended use

Intended use The **VACUU·PURE 10C** is a compact, chemical-resistant, and oil-free operated, air-cooled vacuum pump for the coarse and fine vacuum range in the laboratory. The vacuum pump may only be used indoors in a dry, non-explosive atmosphere.

An attached vapor condenser (accessory) is exclusively intended for the condensation of vapors and for collecting liquids.

Intended use also includes:



- observing the information in the document **Safety information for vacuum equipment**,
- observing the manual,
- observing the manual of connected components,
- regularly inspecting the vacuum pump according to its operating conditions and have this carried out by qualified personnel,
- using only original **VACUUBRAND** parts and approved accessories or spare parts.

Any other use is considered improper use.

2.1.2 Improper use

Improper use Incorrect use or any application which does not correspond to the technical data may result in injury or damage to property.

Improper use includes:

- using the product contrary to its intended use,
- using the product in non-commercial environments, unless the necessary protective measures and precautions have been taken by the company,
- operation under inadmissible environmental and operating conditions,
- operation despite obvious errors or defective safety devices,
- unauthorized extensions, conversions, or repairs, in particular when these impair safety,
- the use of unauthorized accessories or spare parts,
- usage despite incomplete assembly,
- operation by insufficiently trained or qualified personnel,
- switching on/off with tools or one's foot,
- operation with sharp-edged objects,
- pulling plug-in connections on the cable out of the socket,
- extracting or conveying solids or liquids.

2.1.3 Foreseeable misuse

Misuse In addition to improper use, there are types of use which are prohibited when handling the product:



Prohibited types of use include, in particular:

- use on humans or animals,
- installation and operation in potentially explosive atmospheres,
- use in mines or underground,
- unauthorized modifications,
- switching on/off with tools or one's foot,
- operation with sharp-edged objects,
- using the product to generate pressure,
- fully exposing the product to the vacuum, immersing it in liquids, exposing it to water spray or steam jets,

- misuse
- pumping oxidizing and pyrophoric substances, liquids or solids,
 - pumping hot, unstable, or explosive media,
 - pumping substances which may react explosively under impact and/or elevated temperature without an air supply.

IMPORTANT!

No foreign bodies, hot gases or flames from the application must be allowed to enter the equipment.

→ see chapter: 8.1.1 Technical data on page 78.

2.2 Obligations

2.2.1 Operator obligations

Operator obligations

The owner defines the responsibilities and ensures that only trained personnel or specialists work on the product. This applies in particular to connection work and troubleshooting.

Users must have the appropriate qualifications for the listed activities, see *Responsibility matrix*. In particular work on electrical equipment must be performed only by qualified electricians.

2.2.2 Personnel obligations

Personnel obligations

In the case of activities which require protective clothing, personal protective equipment as specified by the operator is to be worn.

If the product is not in proper working order, it must be prevented from being accidentally switched back on.

- ⇒ Always be conscious of safety and work in a safe manner.
- ⇒ Observe instructions issued by the operator, and national regulations on accident prevention and industrial safety.



The way individuals act can help to prevent accidents at work.

2.3 Target group description

Target groups The manual must be read and observed by every person who is tasked with the activities described below.

Personnel qualification

Qualification description

Operator	Laboratory staff, such as chemists, laboratory technicians
Specialist	Person with professional qualification in mechanics, electrical equipment or laboratory devices
Responsible specialist	Specialist with additional specialist, departmental or area responsibility

Responsibility matrix

Responsibility matrix

Activity	Operator	Specialist	Responsible specialist
Transport	x	x	x
Installation	x	x	x
Commissioning	x	x	x
Operation	x	x	x
Updates			x
Error report	x	x	x
Remedy	(x)	x	x
Repair order			x
External cleaning	x	x	x
Rinsing/purging	x	x	x
Clean the filter at the air intake and fan grilles	x	x	x
Empty the separator	x	x	x
Shutdown		x	x

2.4 General safety information

Quality standard
and
safety

Products from **VACUUBRAND GMBH + CO KG** are subject to stringent quality testing with regard to safety and operation. Each product undergoes a comprehensive test program prior to delivery.

⇒ Observe the instructions for all actions as specified in this manual.

2.4.1 Safety precautions

Safety precautions

⇒ Use your product only if you have understood its function and this manual.

⇒ Replace defective parts immediately, e.g., a broken power cord, faulty hoses, or faulty flasks.

⇒ Use only original accessories and components which are designed for the vacuum technology, such as a vacuum hose, separator, vacuum valve, etc.

⇒ When handling contaminated parts, follow the relevant regulations and protective measures; this also applies to equipment sent in for repair.

Prior to returning any product to our Service Department for repair, contamination from hazardous substances needs to be excluded.

IMPORTANT!

⇒ Therefore, send us the carefully completed and signed [Health and Safety Clearance](#) certificate before sending your product for repair.

2.4.2 Protective clothing

Protective clothing

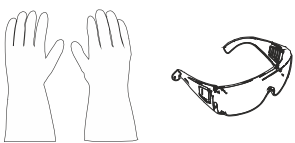

No special protective clothing is required to operate the vacuum pump. Observe instructions issued by the operator for your workplace.

During cleaning, we recommend wearing chemical-resistant protective gloves, protective clothing, and protective goggles.

IMPORTANT!

⇒ When handling chemicals, wear your personal protective equipment.

2.4.3 Laboratory and working materials

	DANGER
	<p>Hazardous substances could be discharged at the outlet.</p> <p>During aspiration, hazardous, toxic substances at the outlet can get into the ambient air.</p> <ul style="list-style-type: none"> ⇒ Observe the relevant safety regulations for safe handling of hazardous substances. ⇒ Please note that residual process media may pose a danger to people and the environment. ⇒ Mount and use suitable separators, filters or fume hood devices.

- ⇒ Prevent the release of hazardous, toxic, explosive, corrosive fluids, gases or vapors or those that are harmful to health or the environment, for example, through suitable laboratory facilities with a fume hood and ventilation control.

Hazards due to different substances

Pumping different substances

Pumping different substances or media can cause the substances to react with one another.

- ⇒ Be aware of interactions and possible chemical reactions of the pumped media.
- ⇒ Dry the vacuum pump with ambient air before changing the medium to be pumped. Use the regeneration mode of the vacuum pump for this purpose
→ see chapter: *5.2.2 Regeneration mode on page 47.*

2.4.4 Chemical compatibility of materials

Compatibility of the vacuum pump with pumped substances

Working materials which get into the vacuum pump with the gas flow can damage the vacuum pump. Substances can be deposited in the vacuum pump.

- ⇒ Check the compatibility of the pumped substances with the wetted materials of the vacuum pump
→ see chapter: *8.1.3 Wetted materials on page 83* and *8.1.4 Use of chemicals on page 84.*

2.4.5 Eliminate sources of danger

Connect the tubing correctly

Avoid overpressure

No inadmissible pressure must be created at the vacuum pump outlet. If the back pressure at the outlet is inadmissibly high, pumped media may escape, → see *chapter: 8.1.1 Technical data on page 78*.

- ⇒ Always ensure that the outlet line is clear and has no back pressure. The outlet must not be blocked, to ensure that gases can exit freely.
- ⇒ Prevent uncontrolled overpressure (e.g., due to a locked or blocked piping system, condensate, or clogged outlet line).
- ⇒ At the gas connections, the connections for the inlet and outlet must not be mixed up. The inlet is indicated by a directional arrow on the connecting flange.
- ⇒ Observe the maximum pressures at the inlet and outlet of the vacuum pump, as specified in *chapter 8.1.1 Technical data on page 78*.
- ⇒ The system to be evacuated as well as all hose connections must be mechanically stable.
- ⇒ Attach hoses to optional hose nozzles (e.g., vapor condenser, adapters at pump connections) so that they do not come loose unintentionally.

Sealing gas to protect the vacuum pump

Sealing gas supply

To protect the bearings of the vacuum pump, a permanent gas flow (ambient air sucked in inside the pump casing, hereinafter referred to as sealing gas) is added at the outlet side of the suction chamber. This mixes with the pumped media and is conveyed to the pump outlet. Pumped media can form reactive mixtures with the sealing gas (ambient air).

- ⇒ Do not use the vacuum pump in processes in which the pumped media can form an explosive mixture with air.

Danger when using regeneration mode

- Regeneration mode During regeneration mode, ambient air passes through the pump unit. Pumped media can form reactive mixtures with ambient air.
- ⇒ Make sure that the pumped media combined with air never leads to reactive, explosive, or otherwise dangerous mixtures.

Prevent condensate return

- Condensate in the outlet line Condensate in the outlet line can damage the vacuum pump. Condensate must not flow back into the outlet or vacuum pump through the hose line. Liquid must not accumulate inside the outlet line.
- ⇒ Preferably route the outlet line with a fall from the outlet, i.e., running downward so that no backup forms.

Prevent foreign bodies inside the pump

- Foreign bodies Particles and dust must not enter the vacuum pump during normal operation.
- ⇒ Do not pump any substances which could form deposits inside the vacuum pump.
 - ⇒ Install suitable filters upstream of the inlet. Suitable filters are chemically resistant, clog-proof and have a reliable flow rate, for example.
 - ⇒ Replace porous vacuum hoses without delay.

Hazards during venting

Hazards during venting

The vacuum pump does not create a vacuum-tight seal when it switches off. Depending on the application, venting can cause explosive mixtures to form in systems or other hazardous situations to arise.

⇒ Install a shut-off valve in the inlet line to isolate your application from the vacuum pump with a vacuum-tight seal.

Dangers due to vacuum pump Autostart

Hazards due to automatic restart of the vacuum pump (Autostart)

The vacuum pump has an Autostart function. When the power supply is switched off and then back on, the last active operating state of the vacuum pump is automatically reactivated, e.g.:

- after a power failure,
- after switching the vacuum pump off and on,
- after disconnecting and reconnecting the power plug.

An ongoing process starts automatically when the power supply is disconnected and reconnected.

- ⇒ Check whether this function can be used safely with the planned application.
- ⇒ Ensure that the automatic restart of the process does not pose any danger to persons or equipment.
- ⇒ Take appropriate safety precautions (e.g., shut-off valve, relay switch, protection against restart) if an automatic restart of the vacuum pump can lead to a dangerous situation.
- ⇒ The Autostart function can be deactivated via Modbus RTU protocol, see separate manual for Modbus RTU description.

Hazards due to residual energy

Hazards due to residual energy

After the vacuum pump has been switched off and disconnected from the power supply, there may still be dangers due to residual energy:

- Thermal energy: engine waste heat, compression heat.
- ⇒ Let the vacuum pump cool down before carrying out maintenance work.

Hazards due to overheating

Overheating The vacuum pump can be damaged due to overheating. Possible causes include insufficient air supply to the fan, failure to maintain minimum distances, ambient temperature outside the specified operating conditions. Overheating of the vacuum pump can lead to a reduction in the speed of the vacuum pump or to the vacuum pump being switched off.

- ⇒ When installing the product, ensure that there is a minimum distance of 5 cm between the vacuum pump and adjacent parts (such as the housing, walls, etc.).
- ⇒ Always ensure that there is a sufficient air supply and air extraction to remove the warm exhaust air from the vacuum pump, especially if the vacuum pump is installed in a housing or lab furniture. Provide external forced ventilation.
- ⇒ Place the product on a stable surface. A soft surface such as foam rubber can impair and block the air supply.
- ⇒ Clean polluted ventilation slots.
- ⇒ Avoid excessive heat input due to hot process gases.
- ⇒ Observe the maximum admissible media temperature
→ *see chapter: 8.1.1 Technical data on page 78.*
- ⇒ Allow the vacuum pump to cool down before servicing or cleaning.

Keep signs legible

Labels and signs Keep any signs affixed to the product in an easily readable condition:

- ⇒ Labels
- ⇒ Warning and information signs
- ⇒ Rating plates

2.5 Motor protection

Overheating protection, blockage protection

As overload protection, a temperature sensor is incorporated into the frequency converter. Additionally, the motor current is monitored. In case of excess temperature, exceedance of the current limit, or blockage of the pump, the pump is switched off.

Note: Only manual reset is possible. If the vacuum pump is switched off due to this safety precaution, the error must be cleared manually: Switch off pump or unplug pump from power supply → Determine and eliminate cause of error → Allow pump to cool down and switch vacuum pump back on.

2.6 Disposal

NOTE

Electronic devices must not be disposed of in domestic waste at the end of their service life.

Used electronic devices contain harmful substances that can cause damage to the environment or human health. Disused electrical devices also contain valuable raw materials, which can be recovered for reuse if the device is disposed of correctly within the recycling process.

End users are legally obliged to take used electric and electronic devices to a licensed collection point.

Correctly dispose of all electronic scrap and electronic components at the end of their service life.

⇒ Observe the national regulations regarding disposal and environmental protection.



3 Product description

- Product description The **VACUU·PURE 10C** is a chemical-resistant, oil-free, air-cooled screw vacuum pump for the vacuum range from atmospheric pressure to 10^{-3} mbar in the lab. The pump is equipped with a frequency converter and a switching power supply.
- VACUU·BUS system As a component of the VACUU·BUS system, the vacuum pump offers numerous connection and expansion options for a wide variety of applications.

Product features

Technical characteristics

- The operating principle of the vacuum pump is based on the non-contact gap seal.
- The suction chamber of the vacuum pump is oil-free.
- The drive side of the vacuum pump is protected against corrosion by sealing gas (= aspirated ambient air) through pumped media.
- An internal non-return valve protects the vacuum pump against faulty start-up. A vacuum-tight shutdown can be achieved by an additional external valve.



Material compatibility

Chemical resistant



Compatible with water vapor and condensate

The vacuum pump has a high chemical resistance. The entire wetted area is made of chemical-resistant materials, → see *chapter: 8.1.3 Wetted materials on page 83*.

Due to the high level of water vapor and condensate compatibility of the vacuum pump, no gas ballast is required. Condensate or drops of liquid that enter the vacuum pump with the pumped medium are easily conveyed through the vacuum pump.

Drying function

Regeneration mode

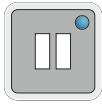

The vacuum pump has an integrated regeneration mode for drying the inside of the pump after the application is finished or before it is taken out of service.

- During regeneration mode, ambient air is fed into the interior of the pump and the interior is dried by the air supply.
- The vacuum pump can remain connected to the process during regeneration.
- During regeneration, the vacuum pump runs at reduced speed.

3.1 VACUU·PURE 10C

Side and front view

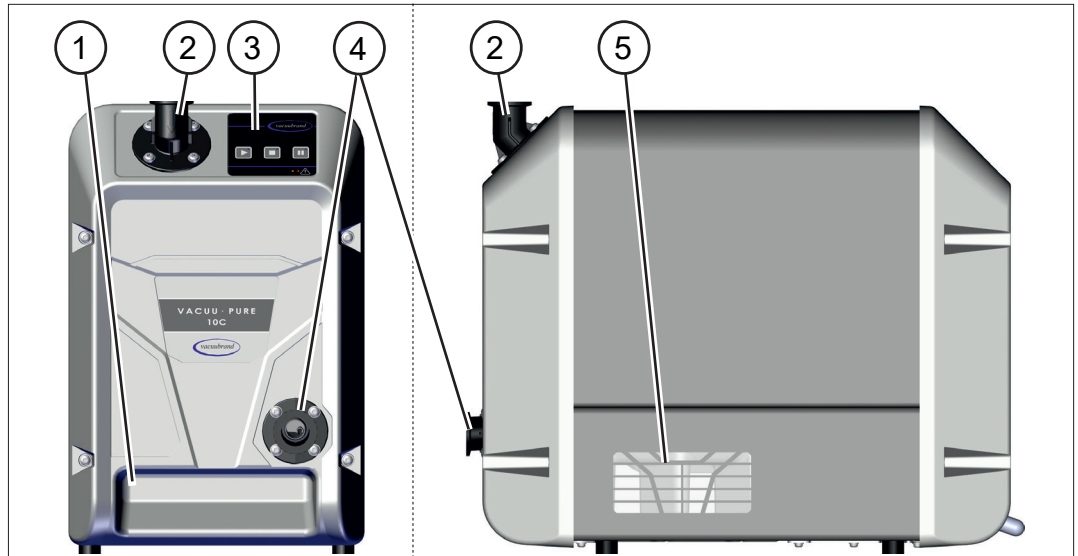

Rear view

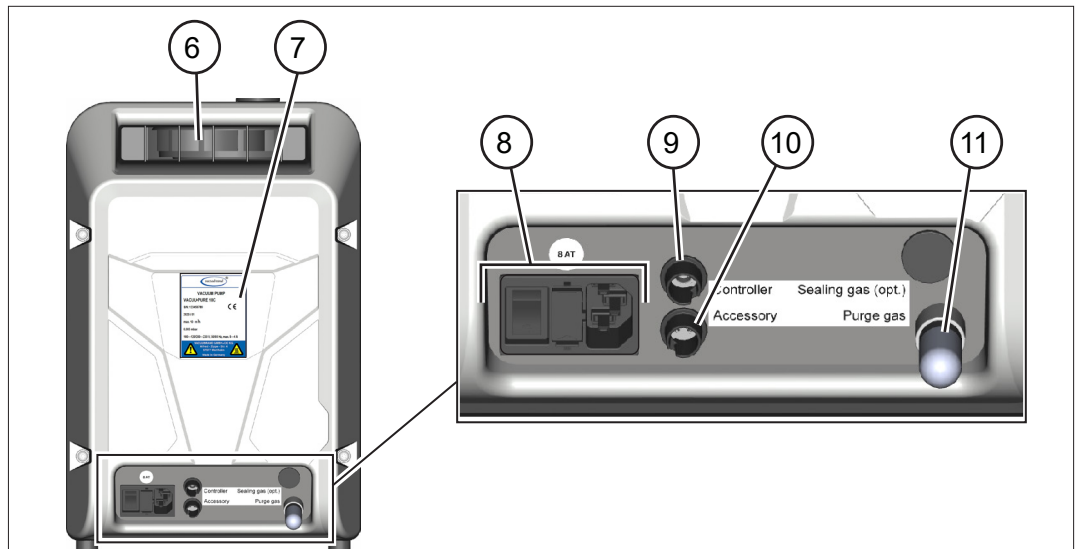

Description

1	Recessed grip on front
2	Inlet – vacuum connection
3	Control panel
4	Outlet – outlet connection
5	Air vents
6	Recessed grip on rear + cooling air outlet
7	Rating plate
8	Mains connection, device fuse, on/off switch
9	VACUU·BUS plug-in connection / Modbus connection
10	VACUU·BUS socket: Accessories
11	Air filter for ambient air supply in regeneration mode

3.2 Optional accessories

→ see also chapter: 8.2 Ordering information on page 85.

3.2.1 Vacuum pump accessories

Optional accessories for the vacuum pump

Separator, vapor condenser and the **VACUU·PURE shuttle** are available as separate accessories for mounting on the vacuum pump.

Separator (AK)

A separator catches liquids and particles and, if required, can be attached directly to the inlet flange by means of a small flange connection KF DN 25.

Vapor condenser (EK)

A vapor condenser is used to recover solvents and is used to condense and collect pumped vapors and liquids.

The vapor condenser is connected directly to the outlet flange by means of a small flange connection KF DN 25.

The vapor condenser also has connections to link to a coolant circuit.

VACUU·PURE shuttle

The shuttle provides the necessary increased ground clearance for mounting the vapor condenser at the vacuum pump outlet.

The shuttle also facilitates the movement of the vacuum pump.

The vacuum pump is mounted directly on the shuttle.

Overview of vacuum pump accessories

Optional accessories:
separator and vapor condenser
VACUU·PURE shuttle

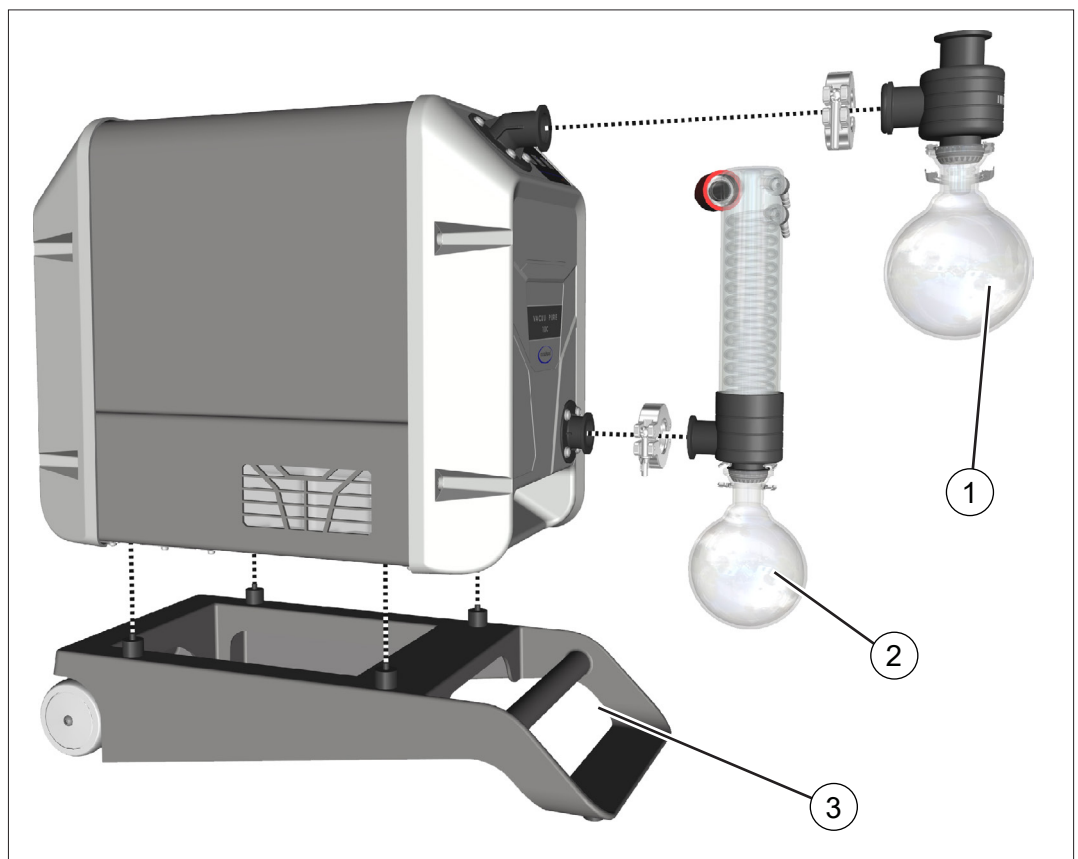

- 1 Separator (AK) at the inlet of the vacuum pump; connection via KF DN 25 (vacuum pump inlet flange rotated)
- 2 Vapor condenser (EK) at the outlet of the vacuum pump; connection via KF DN 25
- 3 **VACUU·PURE shuttle**; required when using the vapor condenser (EK) at the outlet

3.2.2 VACUU·BUS accessories

Connect
VACUU·BUS
components

The lower VACUU·BUS port on the back of the vacuum pump offers a variety of expansion options for connecting VACUU·BUS components.

You can use VACUU·BUS extension cables and Y-adapters to distribute and connect several components.

The maximum permissible total power at the VACUU·BUS socket is 11 W.

Overview of VACUU·BUS accessories

→ Examples
VACUU·BUS
components



Description

1 Vacuum gauge VACUU·VIEW extended 1100 – 0.001 mbar	1.3 W
2 Coolant valve VKW-B	2 W
3 Level sensor	0.1 W
4 In-line solenoid valve VV-B 15C	9.5 W
5 Digital I/O module (fault indication, software version ≥ 1.03)	0.1 W

→ see also chapter: 8.2 Ordering information on page 85.

3.2.3 Modbus RTU protocol

The upper VACUU·BUS port on the back of the vacuum pump is intended for remote operation of the vacuum pump, via Modbus RTU protocol, → *see separate operating manual for description of the Modbus RTU.*

Connection Modbus RTU

→ Examples
Modbus RTU

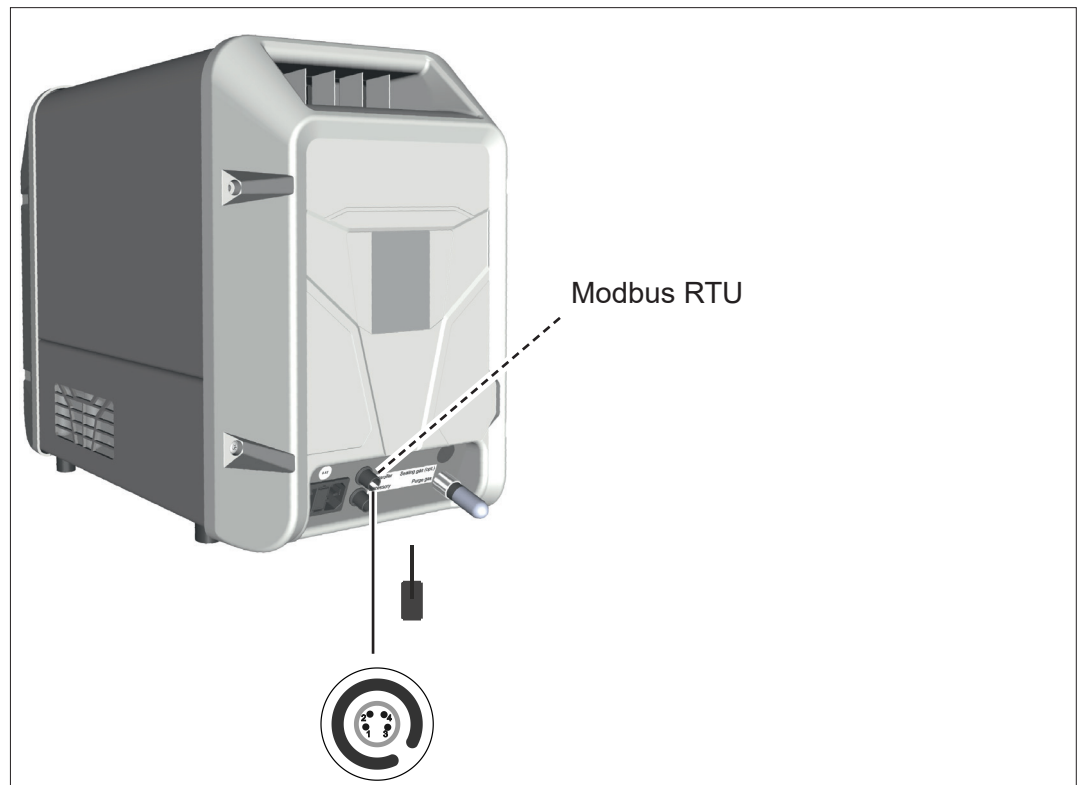

3.3 Application example

Freeze drying

→ Example: Freeze drying

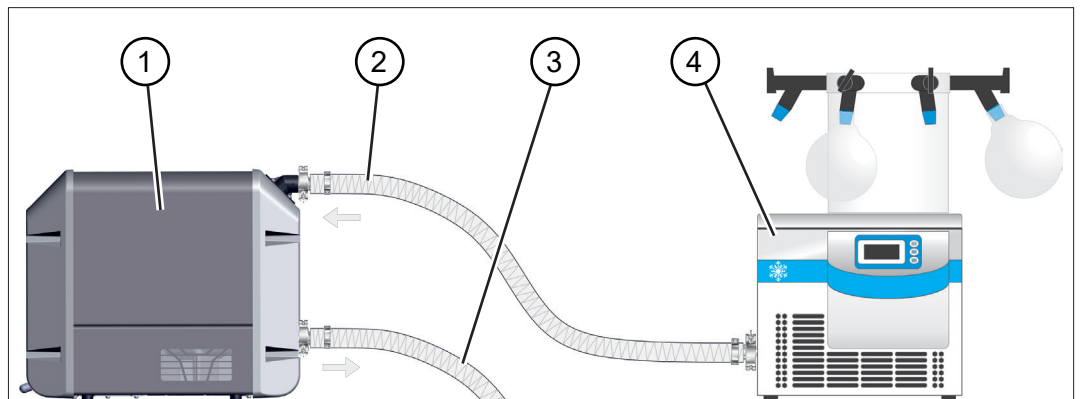

Description

1	Vacuum pump <i>VACUU·PURE 10C</i>
2	Inlet line
3	Outlet line (diverted into a fume hood)
4	Example of use: Lab freeze dryer

4 Installation and connection

4.1 Transport

Products from **VACUUBRAND** are packed in sturdy, recyclable packaging.



The original packaging is accurately matched to your product for safe transport.

If possible, please keep the original packaging, e.g., for returning the product for repair.

Goods receipt

Check the shipment for transport damage and completeness.

⇒ Immediately report any transport damage in writing to the supplier.

Unpacking

→ Example
Vacuum pump in
original packaging

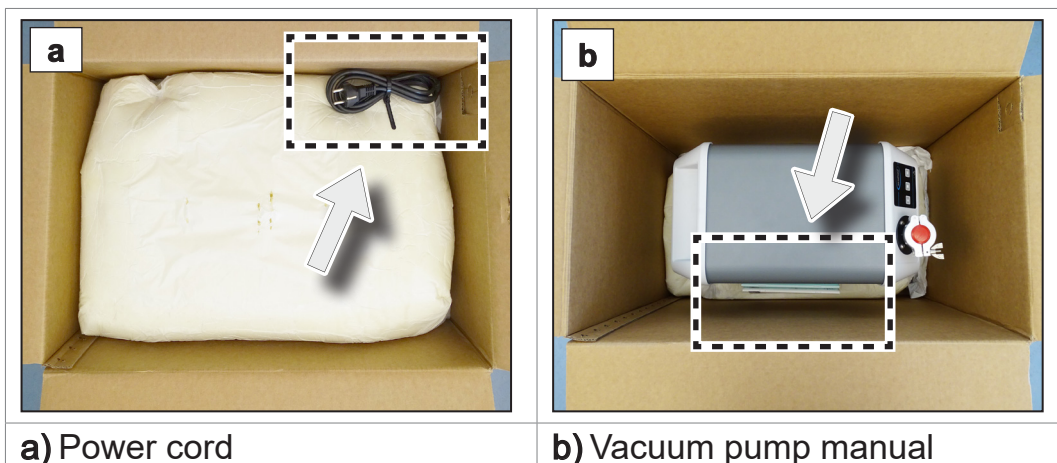

⇒ Remove the upper part of the foam packaging.



⇒ Note that the **weight of the vacuum pump is approx. 21 kg.**

⇒ Carefully lift the vacuum pump out of the packaging using the recessed grips.

4.2 Set up the vacuum pump

NOTE

Condensate can damage the electronics.

A large temperature difference between the storage location and the installation location can cause condensation.

⇒ After goods receipt or storage, allow your product to acclimatize before initial use. The acclimatization can take several hours.

Check installation conditions

Check installation conditions

- The product is acclimatized.
- The ambient conditions are within the limitation of use, → see *chapter: Observe limitation of use on page 34.*
- The vacuum pump must have a stable and secure base without additional mechanical contact apart from the pump feet.

Set up the vacuum pump

→ Example
Sketch of
minimum distances
in lab furniture

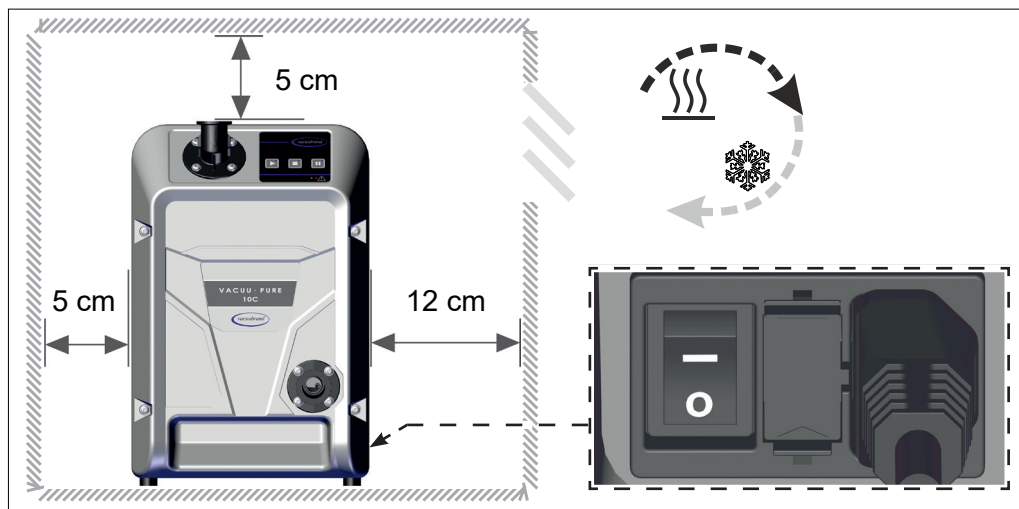

⇒ Place the vacuum pump on a stable, non-vibrating, level surface.

IMPORTANT!

⇒ When installing in lab furniture, maintain a minimum distance of 5 cm (2 in) to adjacent objects or surfaces.

⇒ The product must be positioned so that the on/off switch and the power plug can be reached and are accessible, minimum distance 12 cm (5 in).

⇒ Prevent heat accumulation and ensure sufficient air circulation, especially in closed housings.

⇒ Always ensure that there is an adequate air supply and air extraction to remove the warm exhaust air from the vacuum pump. Provide an external forced ventilation with a volume flow of approx. 100 m³/h when installing in lab furniture.

Observe limitation of use

Observe limitation
of use

Limitation of use	(US)	
Operating ambient temperature	10 – 40 °C	50 – 104 °F
Max. altitude	2000 m above sea level	6562 ft above sea level
Minimum distance to adjacent parts	5 cm (12 cm)	2 in (5 in)
Relative humidity	30 – 85 %, non-condensing	
Pollution degree	2	
Protection class	IP 20	NEMA type 1
Prevent condensation or external contamination from dust, liquids, and corrosive gases.		

IMPORTANT!

- ⇒ Note the IP protection class. IP protection is only guaranteed if the product is appropriately mounted and connected.
- ⇒ When connecting, observe the information on the rating plate and the chapter *8.1.1 Technical data on page 78*.

4.3 Connection

The vacuum pumps have a vacuum connection and an outlet connection. Connect your vacuum pump as described in the examples below.

4.3.1 Vacuum connection (IN)

Vacuum connection
(IN)

The vacuum connection is indicated by a directional arrow on the inlet connector.

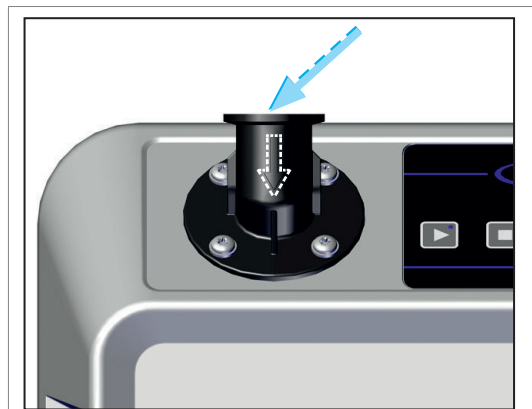

Vacuum connection



CAUTION

Flexible vacuum hoses can contract during evacuation.

Connected components that are not secured can cause injury or damage due to the jerky movement (shrinkage) of a flexible vacuum hose. The vacuum hose can come loose.

- ⇒ Secure the vacuum hose to the connections.
- ⇒ Secure connected components.
- ⇒ Take the maximum shrinkage into account when sizing the flexible vacuum hose.

NOTE

Foreign bodies in the inlet line can damage the vacuum pump.

⇒ Prevent particles and contaminants from being aspirated or being able to flow back.

IMPORTANT!

- ⇒ Use a sufficiently stable vacuum hose that is designed for the required vacuum range.
- ⇒ Keep the vacuum hose as short as possible.
- ⇒ Connect a vacuum hose with as large as possible cross-section.
- ⇒ The connection between vacuum hose and the vacuum pump must be gas-tight.
- ⇒ Avoid kinks in the vacuum hose.

Rotate the inlet flange

The inlet flange can be rotated in 90° increments.

→ Example
Rotate inlet flange
forward



1. Loosen the 4 screws on the inlet flange: Torx screwdriver TX25, paying attention to the washers.



2. Remove the inlet flange. Check the O-ring for damage and that it is correctly seated.

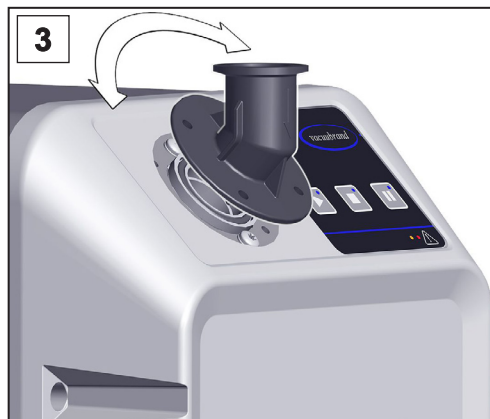

3. Turn the inlet flange in the required direction.



4. Screw on the inlet flange together with the washers; Torx screwdriver TX25.

Connect the vacuum hose

Vacuum hose at the inlet

- ⇒ Remove the blind flange on the inlet flange.
- ⇒ Connect a vacuum hose with small flange KF DN 25 to the inlet flange, ensuring the connection is gas-tight.
- ⇒ Alternatively, you can use an adapter from small flange KF DN 25 on the hose nozzle and attach a vacuum hose to it. Secure hose connections on hose nozzles, e.g., with a hose clip.
- ⇒ If necessary, install an in-line solenoid valve or shut-off valve in the inlet line to isolate your application from the vacuum pump with a vacuum-tight seal.



- Observe the following points for optimum results:
- ⇒ Keep the vacuum line as short as you can with as large a cross-section as possible.

Connect the separator (AK) to the inlet (option)

Separator at the inlet

- ⇒ Connect the separator with small flange KF DN 25 to the inlet flange turned forward, ensuring the connection is gas-tight.
- ⇒ Fasten the separator flask using the joint clamp.



4.3.2 Outlet connection (OUT)

Connect the outlet line to the outlet

	WARNING
	<p>Risk of bursting due to overpressure inside the outlet line.</p> <p>Inadmissibly high pressure in the outlet line can cause the vacuum pump to burst or damage seals.</p> <ul style="list-style-type: none">⇒ The outlet line (exhaust gas, gas outlet) must always be clear and non-pressurized.⇒ Always route the outlet line with a fall or take measures to prevent condensate from flowing back into the vacuum pump.⇒ Observe the maximum admissible pressures and pressure differences.

	WARNING
	<p>Danger of bursting due to closed vacuum pump outlet.</p> <p>A closed vacuum pump outlet (blind flange) leads to inadmissibly high pressure at the vacuum pump outlet and can cause the vacuum pump to burst or damage seals.</p> <ul style="list-style-type: none">⇒ Remove the blind flange (transport lock) from the pump outlet flange before starting the pump.

	CAUTION
	<p>Excess pressure at the outlet can cause pumped media to escape.</p> <p>If the outlet is blocked, pumped media can escape from the vacuum pump via the sealing gas supply and cause personal injury and/or pump damage.</p> <ul style="list-style-type: none">⇒ Do not block the outlet. Do not kink the outlet line.⇒ Do not install a shut-off valve in the outlet line.⇒ Use an outlet line with a sufficient cross-section.

Connect the outlet line

Outlet line at the outlet

- ⇒ Remove the blind flange on the outlet flange.
 - ⇒ Connect an outlet line with small flange KF DN 25 to the outlet flange ensuring the connection is gas-tight.
 - ⇒ Alternatively, you can use an adapter from small flange KF DN 25 on the hose nozzle and attach the outlet line to it. Use an outlet line with an interior diameter of at least 19 mm, → *see chapter: 8.2 Ordering information on page 85*. Secure hose connections on hose nozzles, e.g., with a hose clip.
 - ⇒ Route the outlet line with a fall from the outlet, i.e., running downward so that no backup forms.
 - ⇒ The length of the outlet line must not exceed 5 m. An excessively long outlet line can lead to inadmissibly high back pressure at the outlet and impair the function of the sealing gas.
-

IMPORTANT!

Connect the vapor condenser (EK) (option)

Connect the vapor condenser

- ⇒ The vapor condenser requires increased ground clearance. Mount the vacuum pump e.g., on the *VACUU·PURE shuttle* before connecting the vapor condenser → *see chapter: 8.2 Ordering information on page 85*.
 - ⇒ Connect the vapor condenser with small flange KF DN 25 to the outlet flange, ensuring the connection is gas-tight.
 - ⇒ Fasten the separator flask using the joint clamp.
-

Front and side view
with mounted vapor
condenser

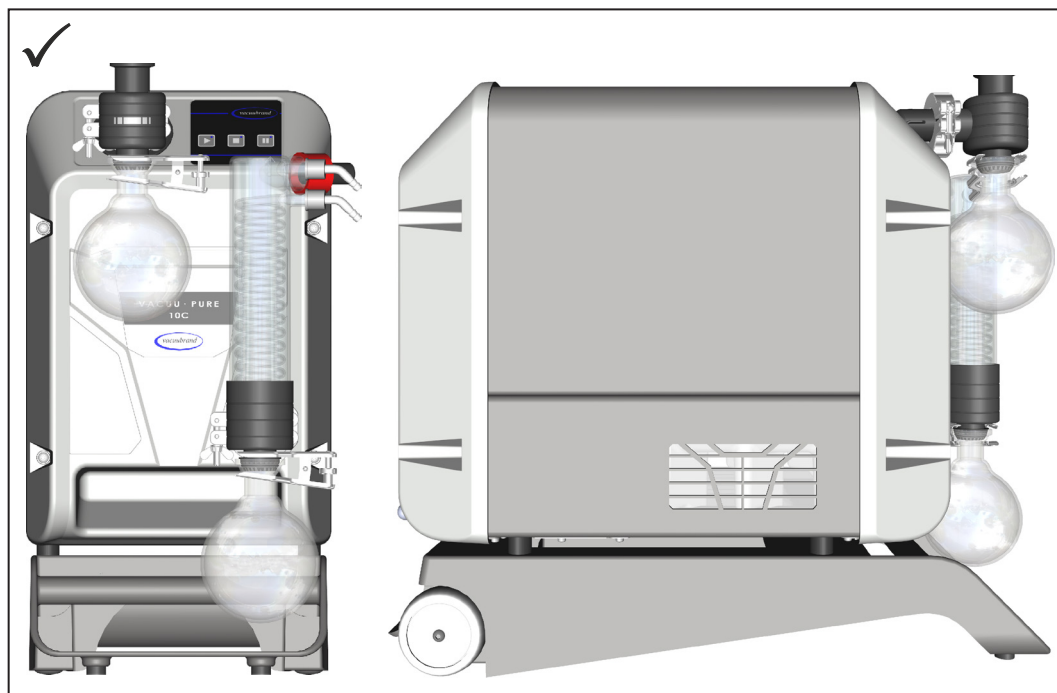

Connect the outlet line

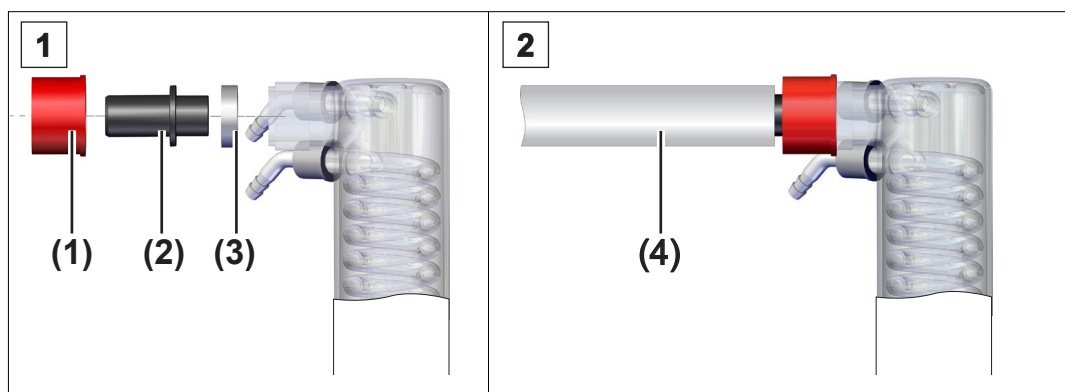

1. Connect rubber sealing ring (3), hose nozzle (2), and union nut (1) as shown and screw them onto the outlet connection.
2. Push outlet line (4) onto the hose nozzle and, if necessary, lay the hose in a fume hood. Fix the outlet line, e.g., with a hose clip.

IMPORTANT!

- ⇒ The length of the outlet line at the vapor condenser must not exceed 3 m. An excessively long outlet line can lead to inadmissibly high back pressure at the outlet and impair the function of the sealing gas. Use an outlet line with an interior diameter of at least 19 mm.

Connect the coolant

A vapor condenser (EK) has a connection for coolant. Water or the liquid from a chiller, for example, are suitable coolants.

IMPORTANT!

- ⇒ The inlet pressure of the coolant at the vapor condenser must be less than 6 bar (87 psi).
- ⇒ A coolant valve may only be installed in the feed line; the coolant drain must be clear and non-pressurized.

→ Example
Coolant connection
on the EK

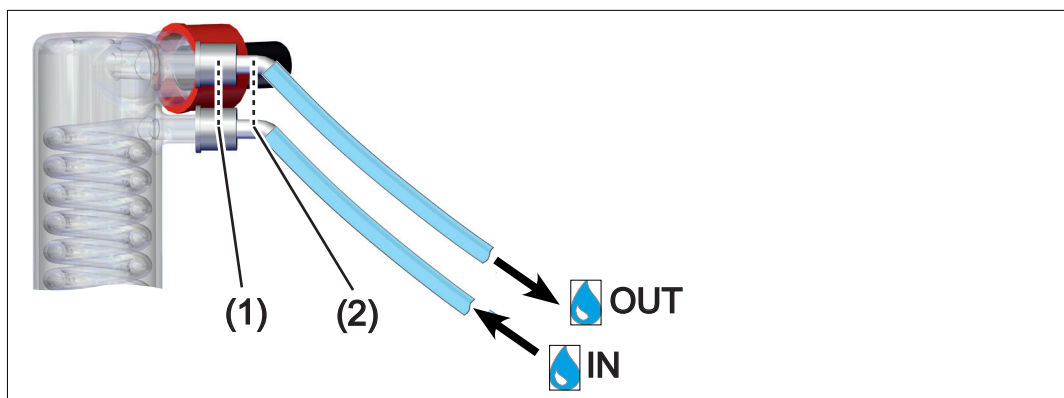

1. Fasten both hose shafts (2) to the condenser with union nuts (1) as shown in the diagram.
2. Attach the hoses for the coolant as shown:
IN = inlet, OUT = outlet.
3. Secure the hoses, e.g., with hose clips.

Limitation of use		(US)
Coolant connection max. pressure	6 bar	87 psi

4.3.3 Electrical connection

Connect the vacuum pump electrically

→ Example
Electrical connection
for vacuum pump

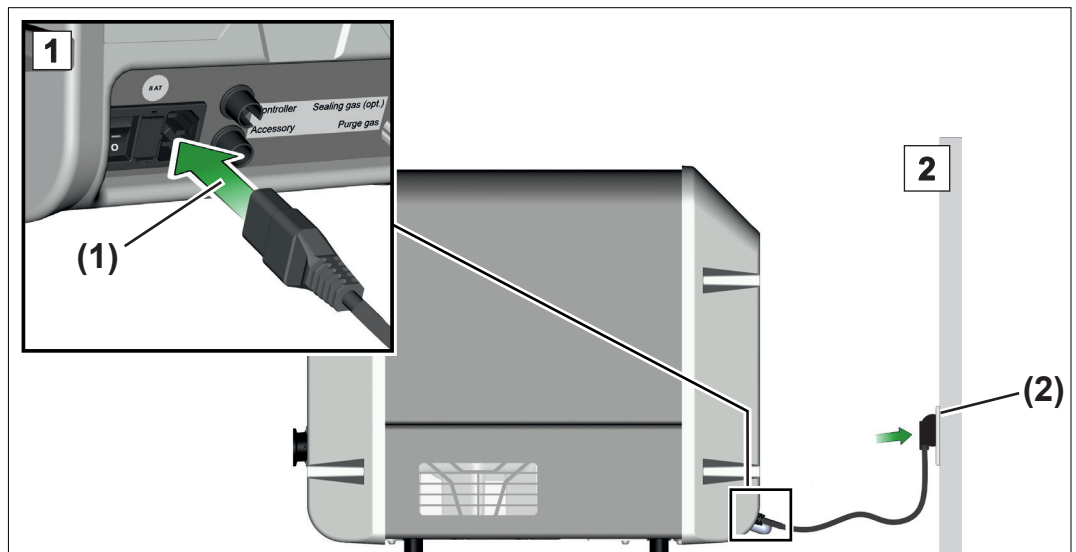

1. Plug connector **(1)** of the power cord into the power connection of the vacuum pump.
2. Plug power plug **(2)** into the power outlet.
 - Vacuum pump electrically connected.

- ⇒ Lay the power cord such that it cannot be damaged by sharp edges, chemicals, or hot surfaces.
- ⇒ The power plug serves as a disconnecting device from the electrical supply voltage. The product must be installed in such a way that the power plug is easily reached and accessible at all times to disconnect the product from the mains supply.

Mains connection

The vacuum pump is delivered ready for use with the appropriate power plug.

- ⇒ Use the power plug which fits your power supply.
- ⇒ Do not use multiple sockets connected in series as the power connection.

5 Commissioning (operation)

5.1 Switch on

Switch on the vacuum pump

Switch on the vacuum pump

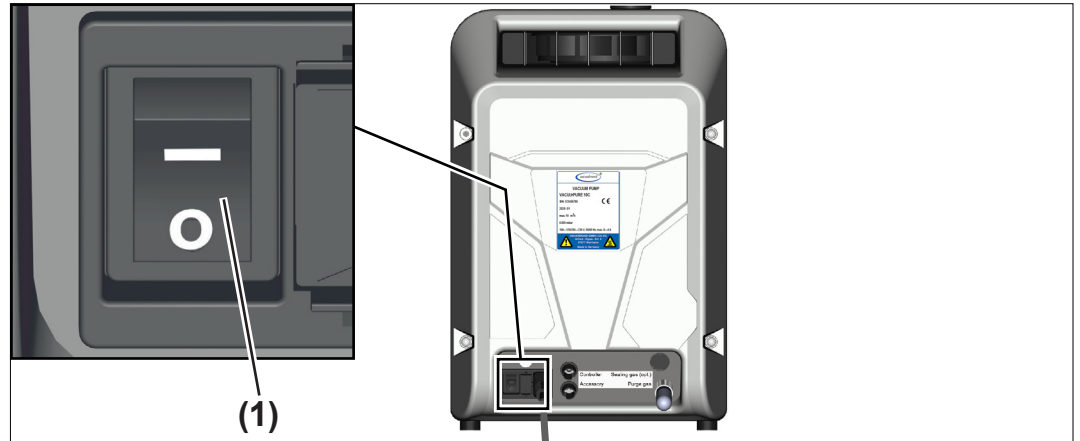

⇒ Switch rocker switch (1) on – switch position I.

- ☑ The vacuum pump carries out a function test, all LEDs light up for 2 seconds. The stop button's blue LED will then light up.

The vacuum pump is ready for operation immediately after switching on.

5.2 Operation

Control panel

Control panel

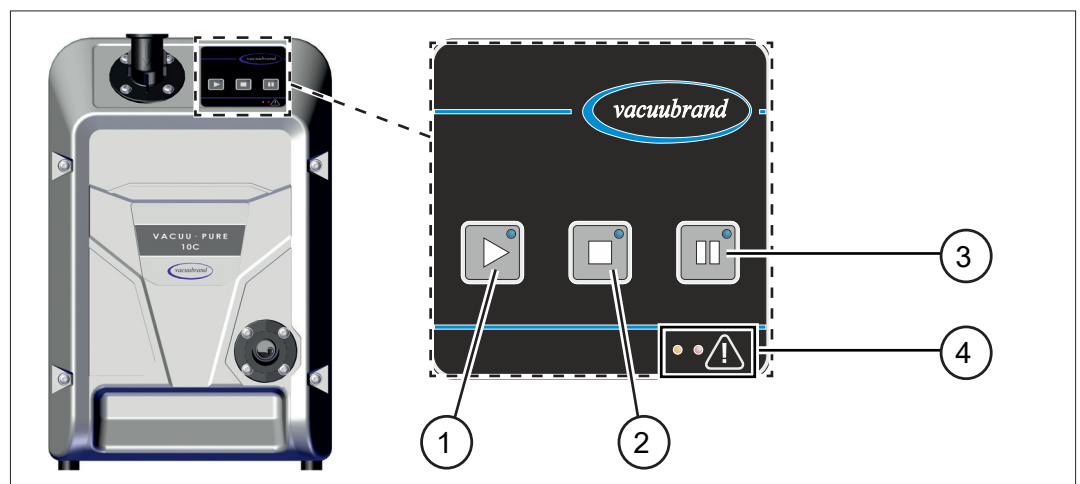

- | | |
|---|--|
| 1 | Start vacuum pump |
| 2 | Stop vacuum pump |
| 3 | Regeneration mode (vacuum pump drying) |
| 4 | LEDs warning (left / yellow) / error (right / red) |





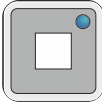
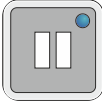

Operating elements





Operating elements

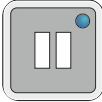



Button	Operating elements
	Start vacuum pump
	Stop vacuum pump
	Vacuum pump regeneration mode (vacuum pump starts/ continues running at reduced speed)

Display elements

Display elements

Button LED	Description
	 Vacuum pump running
	 Vacuum pump stopped
	 Vacuum pump regeneration mode activated

Button LED	Description
All	 Function not active
	 Short flashing  = visual feedback when key is pressed
	 Continuous light = indication for active mode

LED warning / error	Description
	Gray No warning or error active
	Yellow Flashing rate  = warning Continuous light when software version is displayed
	Red Flashing rate  = error Continuous light when hardware version is displayed

5.2.1 Operation

Start the vacuum pump

IMPORTANT!

⇒ Make sure that the outlet is clear and non-pressurized.

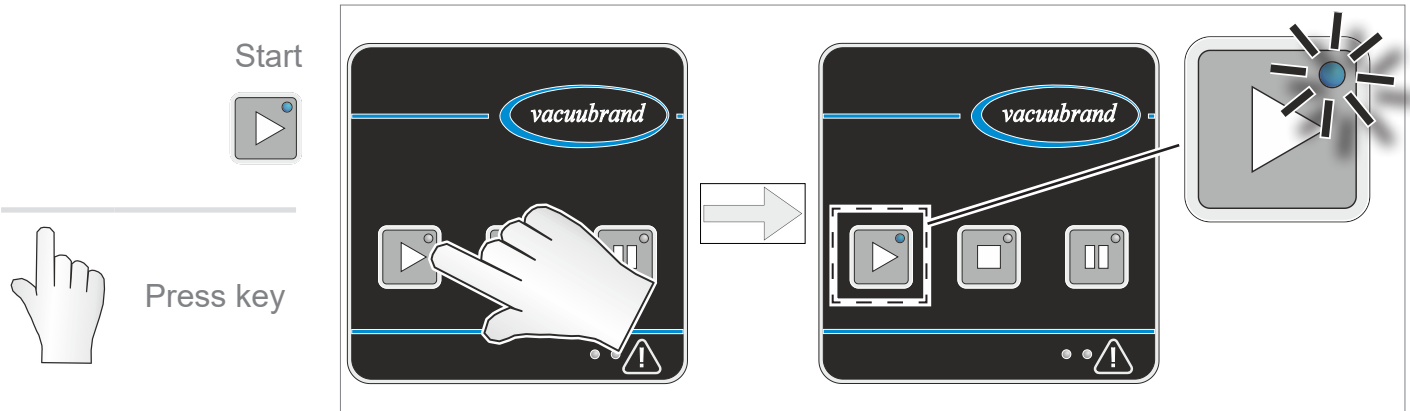

- ☑ The vacuum pump starts. A clicking switch noise can be heard briefly.

Warm-up (warm-up time)

Warm-up time

The operating principle of the vacuum pump is based on gap seals.

⇒ The warm-up time enables the vacuum pump to reach full operating capacity. When pumping down a 100 l boiler, the vacuum pump typically reaches the specified ultimate vacuum after 30 minutes.

VACUU·PURE 10C	Warm-up time (vacuum pump started)	▶ 30 minutes
-----------------------	------------------------------------	--------------

Stop the vacuum pump

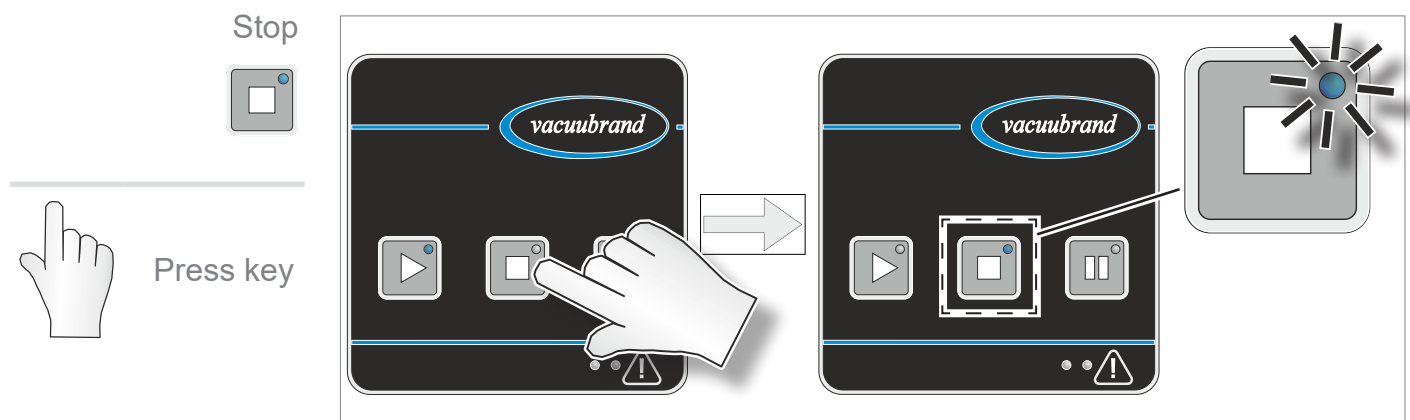

- ☑ The vacuum pump stops. A clicking switch noise may be heard briefly.

IMPORTANT!

- ⇒ The vacuum pump does not create a vacuum-tight seal when it switches off.
- ⇒ If necessary, install an in-line solenoid valve or shut-off valve in the inlet line to isolate your application from the vacuum pump with a vacuum-tight seal.

5.2.2 Regeneration mode

Drying
(regeneration) with
ambient air

The regeneration mode is used to quickly dry the pump interior after the application is finished or before it is taken out of service. Here, ambient air is fed into the interior of the pump and the interior is dried by the air supply.

- The pump does not need to be separated from the application for regeneration.
- The pump runs at a reduced speed during regeneration.
- The air for regeneration mode is drawn in via a filter on the rear of the vacuum pump. The ambient air is aspirated here.

⇒ Check the filter regularly for dirt and blockages.

⇒ Replace dirty or clogged filters,

→ see chapter: *7.4 Air inlet filter on page 76.*

Start regeneration mode

Start regeneration
mode



Press key

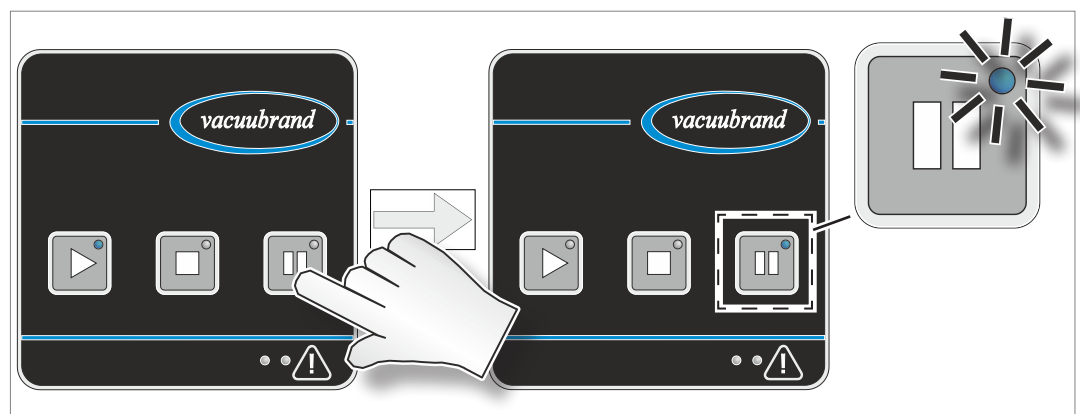

- The vacuum pump runs at a reduced speed and aspirates ambient air.
- The inside of the pump is dried.
- Regeneration mode ends automatically after a period of one hour.

Dry the vacuum pump before changing media

Dry vacuum pump

The vacuum pump can be dried with the aspirated ambient air without having to be separated from the application / equipment.

- ⇒ Use regeneration mode or rinse the vacuum pump with water
→ see *chapter: 7.3 Rinse vacuum pump on page 73*, before changing the pumped medium or the connected process, if pumped media can react with each other in the vacuum pump or form deposits.

Dry the vacuum pump after process end

The vacuum pump can be dried with the aspirated ambient air.

- ⇒ Use the vacuum pump's regeneration mode after the end of the process before stopping or switching off the vacuum pump.
- ⇒ Allow the vacuum pump to continue running in regeneration mode for about 30 minutes after the end of the process. This reduces condensate and media residue in the vacuum pump and thus also the risk of impairment to the vacuum pump by the previously pumped media.

5.2.3 Autostart

Autostart
automatic restart of
the vacuum pump

The vacuum pump has an Autostart function. When the power supply is switched off and then back on, the last active operating state of the vacuum pump is automatically reactivated:

Operating status of the vacuum pump:

before discontinuation of mains voltage	after restoration of the mains voltage
Vacuum pump started	Vacuum pump starts automatically
Vacuum pump stopped	Vacuum pump stopped
Regeneration mode active	Regeneration mode automatically active

- ⇒ Stop the vacuum pump with the stop button before switching off the power switch or pulling the power plug.

- This is how you will avoid an unintentional or unexpected start of the vacuum pump the next time it is switched on.

5.3 Advanced operation

In addition to the simple operation of the vacuum pump – start, stop, regeneration – you can carry out other functions by pressing and holding individual keys or by combining them.

5.3.1 Display of software / hardware version

Display of software / hardware version



Keep key pressed

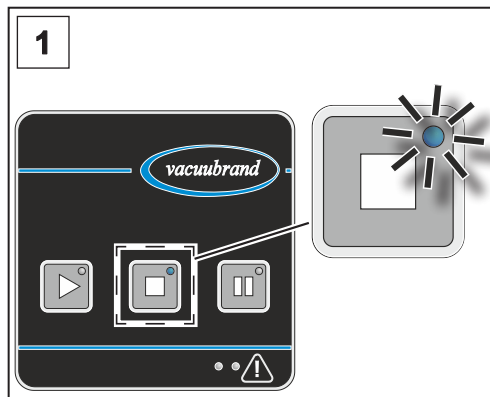

1. The vacuum pump is switched on and stopped.

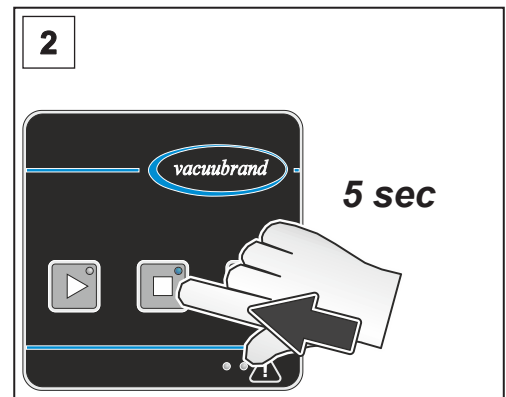

2. Press and hold the stop button for 5 seconds.

⇒ The warning and error LEDs indicate whether the software or hardware version is currently being displayed:



- Yellow LED (left) for warning lights up: Software version displayed





























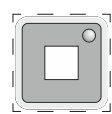

- Red LED (right) for errors lights up: Hardware version displayed

⇒ The software version and the hardware version are indicated alternately by successive flashing of the LEDs on the operating buttons.

Example

Display of software version V1.23 (LED on left, yellow) and hardware version V1.05 (LED on right, red):

LEDs	Meaning / flashing rate
  Yellow	Software version display (1 second)
  Yellow	 1x  = V 1.XX
  Yellow	 2x  = V X.2X
  Yellow	 3x  = V X.X3
	3 seconds pause, LED changes from yellow to red
  Red	Hardware version display (1 second)
  Red	 1x  = V 1.XX
  Red	 Not flashing = V X.0X
  Red	 5x  = V X.X5
	3 seconds pause – then the display starts again from the beginning

⇒ Exit the display by briefly pressing the stop button or automatically after 5 minutes.

5.3.2 Restore factory settings

Restore factory settings

When restoring the factory settings, any changes made by the customer – mainly with accessories optionally connected via VACUU·BUS – will be reset to factory settings.

⇒ The software version of the vacuum pump is retained and is not reset.



Keep key pressed

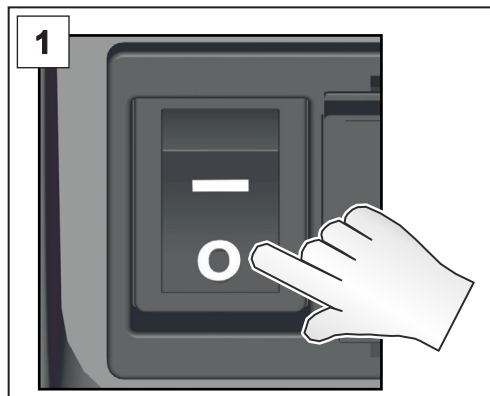

1. Turn off the power switch. Wait 10 seconds until the vacuum pump is completely off.

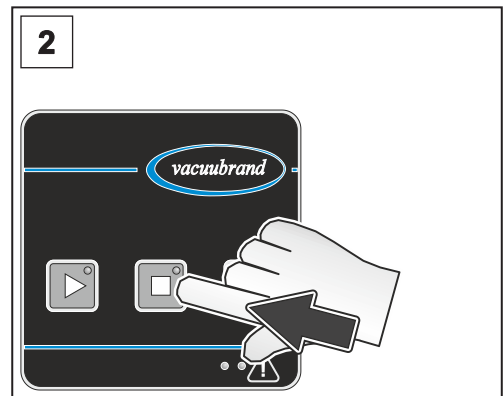

2. The vacuum pump is switched off. Press and hold the stop button.

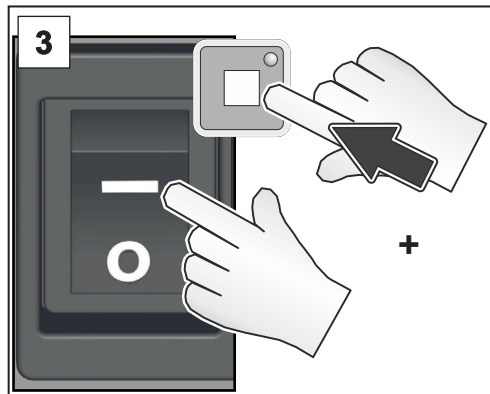

3. Turn on the power switch while continuing to hold down the stop button.

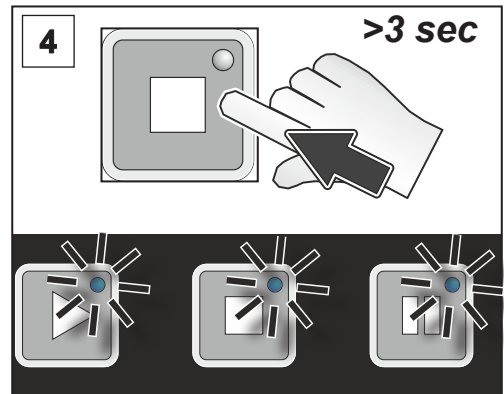

4. Press and hold the stop button for another 3 seconds until all button LEDs flash, then release the stop button.

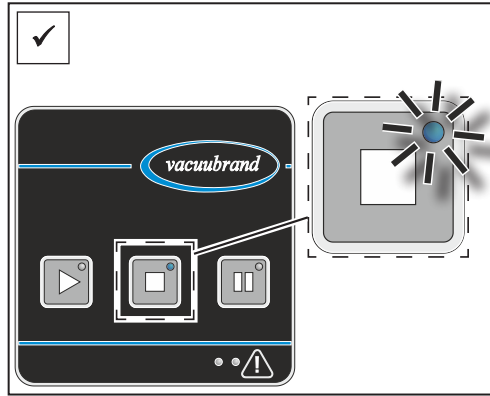

- The stop button lights up permanently. The vacuum pump's factory settings are restored.

5.3.3 Remote operation via Modbus RTU

Modbus RTU:
Remote operation
and parameter
setting

The upper VACUU·BUS port on the back of the vacuum pump is intended for remote operation of the vacuum pump, via Modbus RTU protocol. Via the Modbus RTU protocol, parameters of the vacuum pump (Autostart) and of VACUU·BUS accessories (coolant valve run-on time, delay time of the level sensor) can also be set, → *see separate operating manual for description of the Modbus RTU interface.*

5.4 Connect / remove VACUU·BUS accessories

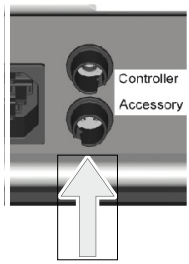

Connect
VACUU·BUS
accessories

Connect VACUU·BUS accessories

1. Stop the vacuum pump and switch off the vacuum pump at the power switch.
2. Insert the VACUU·BUS plug of the accessory into the lower socket on the back of the vacuum pump.
3. Switch on the vacuum pump at the power switch. The connected accessories are automatically detected.

VACUU·BUS accessories connected.

Remove VACUU·BUS accessories.

Remove
VACUU·BUS
accessories

1. Stop the vacuum pump and switch off the vacuum pump at the power switch.
2. Unplug the VACUU·BUS accessories on the back of the vacuum pump.
3. Carry out a BUS scan of the vacuum pump to deregister the accessories from the vacuum pump BUS system, → see *chapter: 5.4.1 VACUU·BUS detection on page 54*.

VACUU·BUS accessories removed.

General notes on VACUU·BUS components

VACUU·BUS
accessories –
General information

- Use Y-adapters and extension cables to connect and use several VACUU·BUS components in parallel.
- A maximum of six VACUU·BUS components can be connected and used in parallel.
- A maximum of four components of the same type can be connected.
- Each connected VACUU·BUS component must have a different VACUU·BUS address. The connection of two components with identical VACUU·BUS addresses leads to errors in the BUS system. (Reconfiguration of the VACUU·BUS address of a component: see operating manual of a VACUUBRAND controller, e.g., VACUU·SELECT).
- Note the maximum permissible load of 11 W at the VACUU·BUS port.

- Maximum permissible cable length in the VACUU·BUS system: 30 m.
- An interruption in communication with accessories or the removal of accessories causes the vacuum pump to stop immediately and an error message to be displayed (flashing rate: 6x), → see *chapter: 6.3.2 Error – Cause – Remedy on page 62*.

5.4.1 VACUU·BUS detection

IMPORTANT!

⇒ When performing a VACUU·BUS detection, an optionally connected level sensor will be calibrated as well. In that case, ensure that the receiving flask is empty.

Perform BUS scan (VACUU·BUS)

Perform BUS scan



Keep key pressed

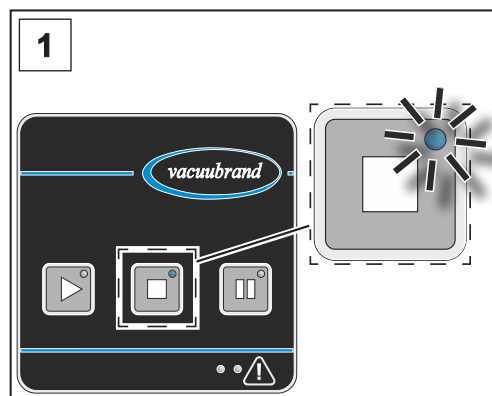

1. The vacuum pump is switched on and stopped.

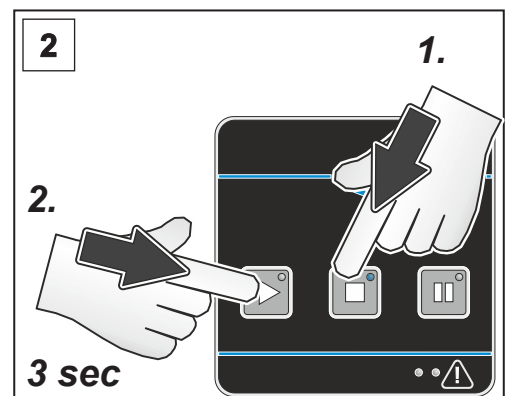

2. First hold down the stop button and then also hold down the start button for 3 seconds.

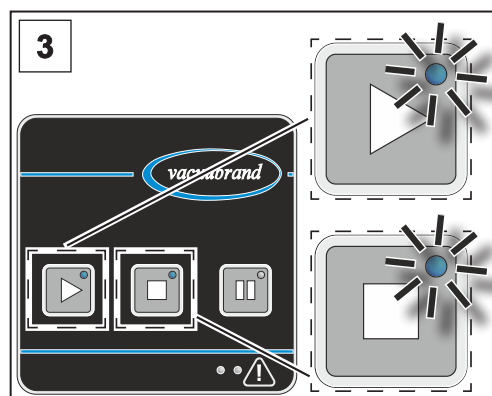

3. The LEDs for the stop and start buttons flash for 5 seconds.

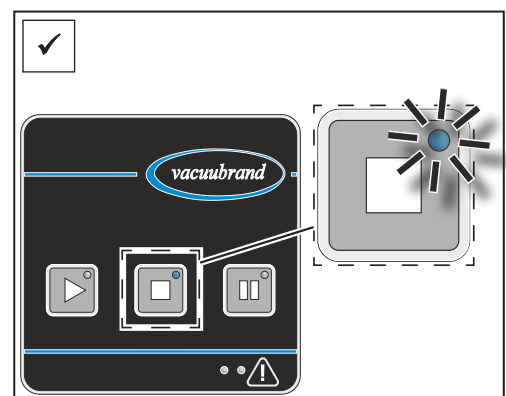

☑ The stop button lights up. The bus scan is completed. The connected accessories are detected.

5.4.2 Operation with VACUU-BUS accessories

Operation with in-line solenoid valve

Operation with
in-line solenoid
valve

- The in-line solenoid valve automatically opens 10 seconds after the start button is pressed. The value of the waiting time can be set via the Modbus RTU protocol: 0 – 3600 seconds.
- The in-line solenoid valve closes immediately after pressing the stop button or the regeneration button.

Operation with coolant valve

Operation with
coolant valve

- Use a coolant valve when operating with a vapor condenser and water cooling.
- The coolant valve automatically opens after pressing the start button.
- After pressing the stop button or the regeneration button, the coolant valve closes automatically after the run-on time has elapsed. The factory default run-on time is 300 seconds, the value of the run-on time can be set via the Modbus RTU protocol: 0 – 3600 seconds.
- Pressing the stop button again in stop mode resets the coolant valve run-on time; the run-on time starts again.
- Pressing the regeneration button again in regeneration mode resets the coolant valve follow-up time; the run-on time starts again.

Operation with level sensor

Operation with level
sensor

- The level sensor monitors the liquid level in the receiving flask of the vapor condenser or separator.
- The level sensor triggers as soon as the liquid level in the piston reaches the height of the sensor, a warning is displayed.
- When a warning message is displayed, a delay time of 300 seconds starts running at the same time. The value of the delay time can be set via the Modbus RTU protocol: 0 – 3600 seconds.
- By pressing the start button again in start mode, the delay time of the level sensor is reset, the delay time starts again.

- After the delay time has expired, the vacuum pump stops automatically, and an error is displayed.
- In case of a false alarm with empty flask, a calibration should be carried out on the empty flask used:

Calibrate level sensor

Adjust liquid level sensor



Keep key pressed

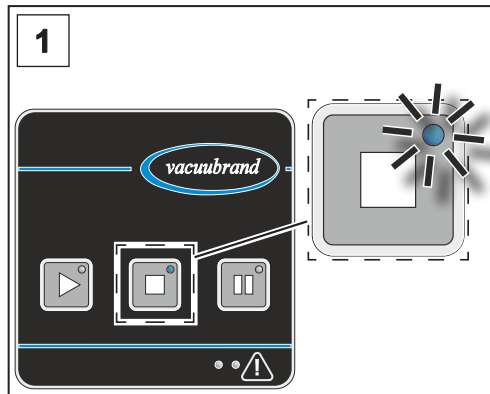

1. The vacuum pump is switched on and stopped. The receiving flask is empty.

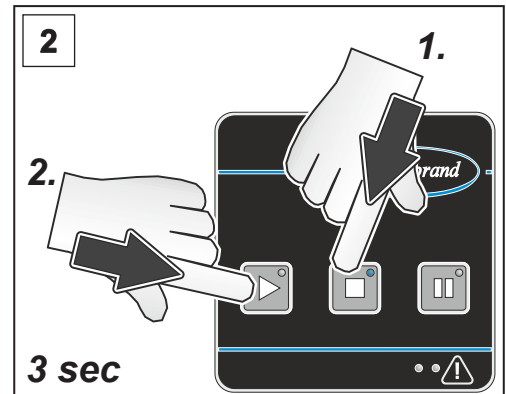

2. First hold down the stop button and then also hold down the start button for 3 seconds.

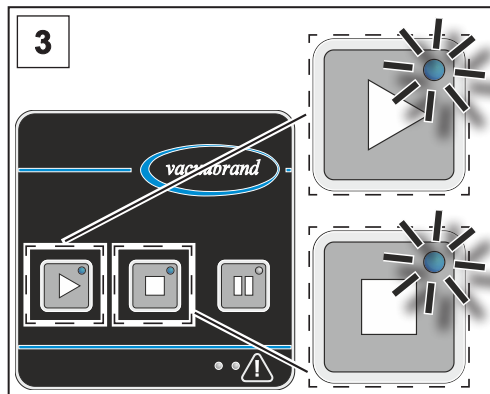

3. The LEDs for the stop and start buttons flash for 5 seconds.

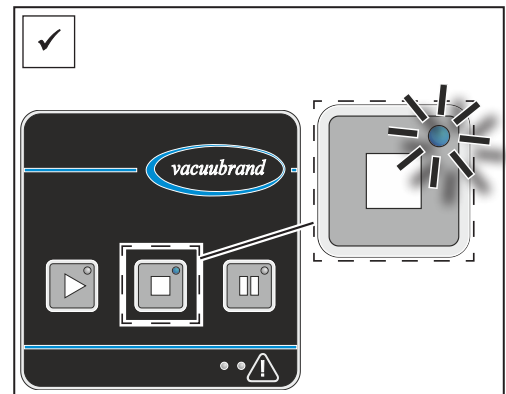

☑ The stop button lights up. The level sensor is calibrated.

5.5 Shutdown (switch off)

Shutdown **Take the vacuum pump out of operation**

1. Stop the process.

IMPORTANT!

⇒ Avoid deposits and dry the vacuum pump in regeneration mode.

- ✓ By letting the vacuum pump run on in regeneration mode, you reduce condensate and media residue in the vacuum pump.
- ✓ You reduce the risk of a possible impairment of the vacuum pump by the previously pumped media by letting the vacuum pump run on.



Press key

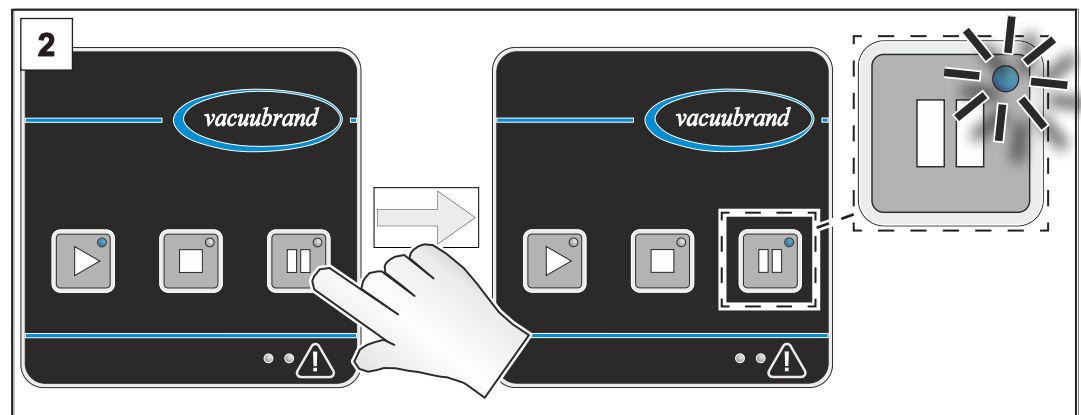

2. Allow the vacuum pump to run on for about 30 minutes in regeneration mode.



Press key

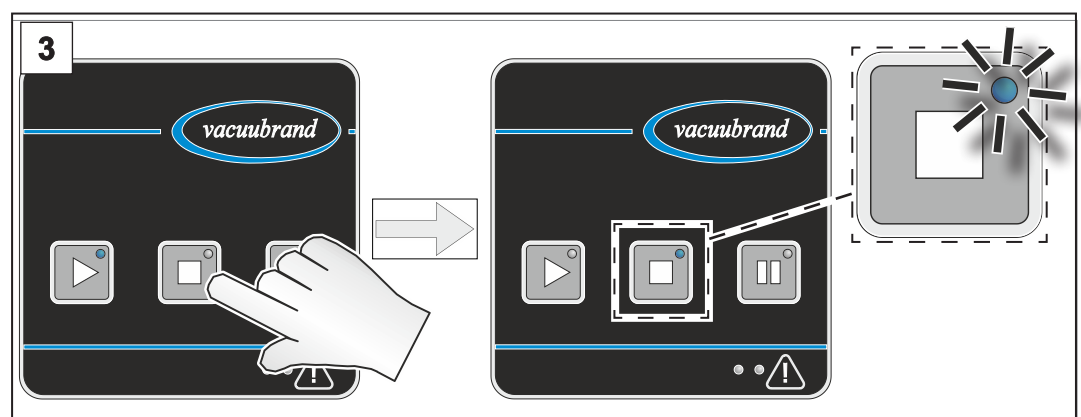

3. Stop the vacuum pump.

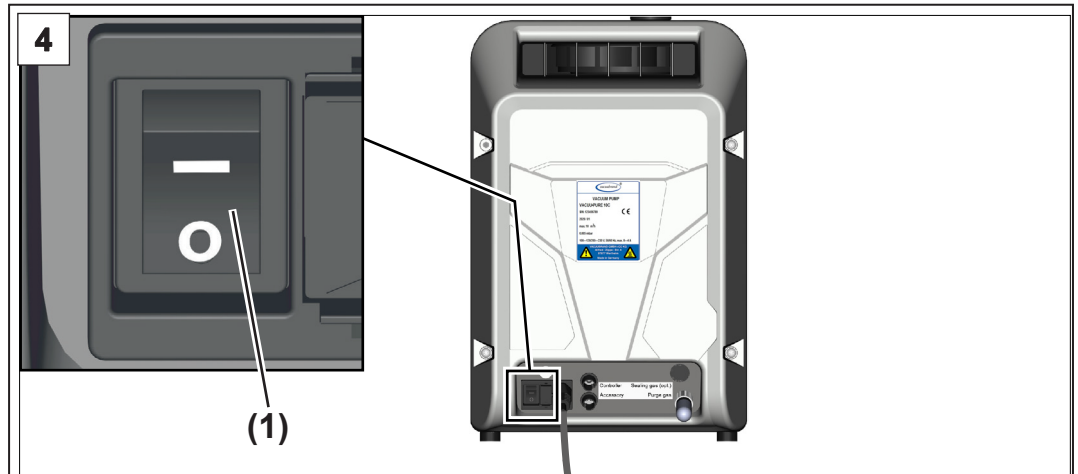

4. Switch off rocker switch (1) – switch position 0.
 - Vacuum pump switched off.
5. Disconnect the vacuum pump from the apparatus.
6. Check the vacuum pump for possible damage and contamination.

5.6 Storage

Store the vacuum pump

Store the vacuum pump

1. Carry out the steps for decommissioning, → see *chapter: 5.5 Shutdown (switch off) on page 57*.
2. Clean the vacuum pump in the event of external contamination.
3. Close the vacuum pump's inlet and outlet, e.g., with the transport locks.
4. Package the vacuum pump such that it is protected from dust; enclose desiccants if necessary.
5. Store the vacuum pump in a cool, dry location.

IMPORTANT!



If damaged parts are stored for operational reasons, these should be clearly identified as **not ready for use**.

6 Error messages

General error messages

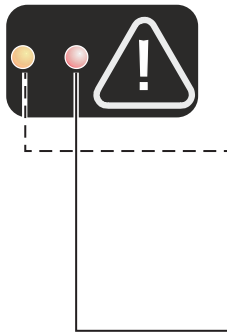





Errors or warnings are indicated by the colored LEDs on the warning triangle. Several error messages may be pending at the same time. Errors and warnings can be read out via the flashing rate.

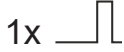

LED	Description
 Gray	No warning or error active
 Yellow	Warning Warning messages reset themselves as soon as the values are back within the normal range. The vacuum pump continues to run if a warning message is received.
 Red	Error The vacuum pump stops as soon as there is an error. If there is an error, all warnings are ignored. First correct the error before resetting.







6.1 Warning display

Possible flashing rates in the event of a warning

Flashing	Description
1x 	Temperature in critical range
2x 	not assigned
3x 	Motor current consumption in critical range
4x 	Fan speed deviation
5x 	Supply voltage for control board in critical range
6x 	Messages: VACUU·BUS accessories (e.g., cooling period for level sensor active, overpressure of a vacuum sensor)
7x 	Other warnings

6.2 Error indication

Possible flashing rates in the event of an error

Flashing	Description
1x 	Temperature in the inadmissible range
2x 	not assigned
3x 	Motor current consumption in faulty range or other motor error
4x 	Fan defective
5x 	Overvoltage or undervoltage in the intermediate circuit of the frequency converter
6x 	Error / communication interruption VACUU·BUS accessories
7x 	Other errors (software versions control board / frequency converter incompatible with each other, other frequency converter errors)

- ⇒ If warnings and errors occur simultaneously, only the errors (red LED) are displayed.
- ⇒ Several errors are indicated one after the other by combined flashing cycles.
- ⇒ An error message is displayed until it is acknowledged. Acknowledge an error message by switching the power switch off and on after you have eliminated the error.

Example

→ Example
Pending error

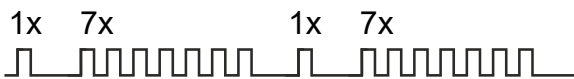
Error	LED flashing rate 
Temperature errors (1x) and other errors (7x) occur at the same time	

Which and how many errors are present can be identified from the flashing cycles.

6.3 Troubleshooting

6.3.1 Technical support

⇒ To identify errors and potential remedies, please refer to the troubleshooting table

Error – Cause – Remedy.

Technical support For technical assistance or errors for which you require additional support, please contact your local distributor or our [Service Department](#)¹.



Only operate the product if it is in perfect working condition.

- ⇒ Perform the recommended service activities, → see ***chapter: 7.1 Information on maintenance work on page 70***, and ensure that the product is in good working order.
- ⇒ Send defective products to our Service Department or your local distributor for repair!

¹ -> Phone: +49 9342 808-5660, fax: +49 9342 808-5555, service@vacuubrand.com

6.3.2 Error – Cause – Remedy

Error – Cause –
Remedy

Error	▶ Possible cause	✓ Remedy	Personnel
Warning flashing rate 1x	▶ Ambient temperature increased.	<ul style="list-style-type: none"> ✓ Observe the vacuum pump's limitation of use. ✓ Ensure a supply of cooling air. 	Specialist
	▶ Minimum clearances not observed when installed in lab furniture.	<ul style="list-style-type: none"> ✓ Maintain minimum clearances to adjacent objects or surfaces. 	
	▶ Cooling air supply blocked; fan grilles dirty.	<ul style="list-style-type: none"> ✓ Ensure a supply of cooling air. ✓ Clean the fan grilles. 	
	▶ Cooling air outlet blocked.	<ul style="list-style-type: none"> ✓ Check and clear the cooling air outlet. Ensure cooling air outlet is kept clear. 	
	▶ Power supply too low, undervoltage.	<ul style="list-style-type: none"> ✓ Check mains voltage. 	
	▶ Pumping down hot process gases.	<ul style="list-style-type: none"> ✓ Observe admissible gas intake temperatures. 	
Warning flashing rate 3x	▶ Motor current consumption in critical range, deposits in pump unit due to pumped media.	<ul style="list-style-type: none"> ✓ Clean the pump unit by rinsing it with water; <i>see chapter: 7.3 Rinse vacuum pump on page 73</i>, and then dry in regeneration mode for at least 60 minutes. 	Operator
	▶ Motor current consumption in critical range during vacuum pump's rinse function.	<ul style="list-style-type: none"> ✓ Reduce the amount of rinsing water. 	
Warning flashing rate 4x	▶ Fan speed deviation.	<ul style="list-style-type: none"> ✓ Remove possible blockage in the cooling air outlet. 	Operator

Error – Cause –
Remedy

Error	▶ Possible cause	✓ Remedy	Personnel
Warning flashing rate 5x	▶ Supply voltage for control board in critical range.	✓ Remove any connected VACUU·BUS accessories if too many or replace if faulty.	Specialist
Warning flashing rate 6x	▶ Message: VACUU·BUS accessories (vacuum sensor overpressure).	✓ Check pressure in system and reduce if necessary. ✓ Check vacuum sensor, calibrate if necessary. Replace defective sensor.	Operator
	▶ Message: VACUU·BUS accessories (cooling period for level sensor active).	✓ Cooling period for level sensor is running (5 min): No action necessary. ✓ Extend cooling period for level sensor. ✓ Empty full receiving flask.	
	▶ Message: VACUU·BUS accessories (level sensor triggers although level has not yet been reached).	✓ Calibrate level sensor or replace defective level sensor.	Specialist
Warning flashing rate 7x	▶ Other warnings.	✓ Send in vacuum pump.	Resp. specialist

Error – Cause –
Remedy

Error	Possible cause	Remedy	Personnel
Error flashing rate 1x	▶ Ambient temperature increased.	<ul style="list-style-type: none"> ✓ Observe the vacuum pump's limitation of use. ✓ Ensure a supply of cooling air. 	Resp. specialist
	▶ Minimum clearances not observed when installed in lab furniture.	<ul style="list-style-type: none"> ✓ Maintain minimum clearances to adjacent objects or surfaces. 	
	▶ Cooling air supply blocked; fan grilles dirty.	<ul style="list-style-type: none"> ✓ Ensure a supply of cooling air. ✓ Clean the fan grilles. 	
	▶ Cooling air outlet blocked.	<ul style="list-style-type: none"> ✓ Check and clear the cooling air outlet. Ensure cooling air outlet is kept clear. 	
	▶ Power supply too low, undervoltage.	<ul style="list-style-type: none"> ✓ Check mains voltage. 	
	▶ Pumping down process gases that are too hot.	<ul style="list-style-type: none"> ✓ Observe admissible gas intake temperatures. 	
Error flashing rate 3x	▶ Motor current consumption in faulty range, deposits in the pump unit due to pumped media.	<ul style="list-style-type: none"> ✓ Clean the pump unit by rinsing it with water; <i>see chapter: 7.3 Rinse vacuum pump on page 73</i>, and then dry in regeneration mode for at least 60 minutes. 	Operator
	▶ Motor current consumption in faulty range during vacuum pump's rinse function.	<ul style="list-style-type: none"> ✓ Reduce the amount of rinsing water. 	
	▶ Motor current consumption in faulty range or other motor error.	<ul style="list-style-type: none"> ✓ In case of unusual operating noises: Send in vacuum pump. 	Resp. specialist
Error flashing rate 4x	▶ Fan jammed.	<ul style="list-style-type: none"> ✓ Remove mechanical blockage from fan. ✓ Remove blockage in cooling air outlet. 	Resp. specialist
	▶ Fan defective.	<ul style="list-style-type: none"> ✓ Send in vacuum pump. 	

Error – Cause –
Remedy

Error	▶ Possible cause	✓ Remedy	Personnel
Error flashing rate 5x	▶ Overvoltage or undervoltage in intermediate circuit (frequency converter).	<ul style="list-style-type: none"> ✓ Check mains voltage. ✓ Send in vacuum pump. 	Resp. specialist
Error flashing rate 6x	▶ VACUU·BUS accessories removed / unplugged.	<ul style="list-style-type: none"> ✓ Plug in VACUU·BUS accessories again and switch vacuum pump off/on. ✓ Operation without VACUU·BUS accessories: Perform BUS scan. 	Operator
	▶ Error or communication interruption in VACUU·BUS accessories.	<ul style="list-style-type: none"> ✓ Check VACUU·BUS plug-in connection to accessories. ✓ Replace defective components. 	
	▶ Receiving flask full. Level sensor triggers, cooling period elapsed.	<ul style="list-style-type: none"> ✓ Empty full receiving flask. 	
Error flashing rate 7x	▶ Other errors (e.g., incompatible software version, other frequency converter errors).	<ul style="list-style-type: none"> ✓ Perform or repeat the software update. Information about software update: VACUUBRAND > Support > Software Updates ✓ Send in vacuum pump. 	Resp. specialist

Error – Cause –
Remedy

Error	▶ Possible cause	✓ Remedy	Personnel
Optional accessories: Vacuum sensor does not display a measured value.	▶ No voltage applied.	✓ Apply mains voltage, switch on vacuum pump.	Operator
	▶ VACUU·BUS plug-in connection or cables defective or not connected.	✓ Check VACUU·BUS plug-in connection and wiring.	
	▶ External plug-in power supply of vacuum sensor not plugged in.	✓ Plug-in power supply for vacuum sensor.	
	▶ Sensor defective.	✓ Replace defective components.	Specialist
Vacuum pump does not start.	▶ Vacuum pump switched off.	✓ Switch on vacuum pump at toggle switch.	Operator
	▶ Power plug not correctly plugged in or pulled out.	✓ Check power supply and cable.	
	▶ Overpressure in the outlet line.	✓ Open the outlet line.	
	▶ Motor overloaded.	✓ Allow the motor to cool down.	Resp. specialist
	▶ Excessive temperature error flashing rate 1x.	✓ See error, flashing rate 1x.	
	▶ Vacuum pump mechanically blocked.	✓ Send in vacuum pump.	
Ultimate vacuum not reached.	▶ Leak in inlet line or in apparatus.	✓ Check inlet line and equipment for leaks.	Operator
	▶ Vacuum pump not at operating temperature.	✓ Allow vacuum pump to warm up for 30 minutes with inlet closed.	
	▶ Leak inside vacuum pump.	✓ Send in vacuum pump.	Resp. specialist



Error – Cause –
Remedy

Error	▶ Possible cause	✓ Remedy	Personnel
No or minimal suction power.	▶ Leak in inlet line or in apparatus.	✓ Check inlet line and equipment for leaks.	Operator
	▶ Optional separator not correctly fitted or sealing ring on separator missing.	✓ Check and correctly install separator.	
	▶ Inlet line too long or cross-section too small.	✓ Use shorter inlet line with larger cross-section.	
	▶ Condensate inside the vacuum pump.	✓ Let vacuum pump run for a few minutes with suction nozzle open or in regeneration mode.	
	▶ Deposits inside the vacuum pump.	✓ Rinse vacuum pump.	Specialist
	▶ High level of vapor generated in the process.	✓ Check process parameter.	
	▶ Pump speed reduced due to excessive temperature.	✓ See warning, flashing rate 1x.	Resp. specialist
Key LEDs do not light up.	▶ Vacuum pump switched off.	✓ Switch on vacuum pump at toggle switch.	Operator
	▶ Power plug not correctly plugged in or pulled out.	✓ Check power supply and cable.	
	▶ Vacuum pump defective.	✓ Send in vacuum pump.	Resp. specialist
Measured leakage current too high	▶ The pump is equipped with a frequency converter and a switching power supply.	✓ Use a suitable measuring method / measuring device.	Specialist

Error – Cause –
Remedy

Error	▶ Possible cause	✓ Remedy	Personnel
Loud operating noises	▶ No outlet line connected.	✓ Check outlet line and connect it correctly.	Operator
	▶ Glass flask on optional EK is missing.	✓ Assemble glass flask.	
	▶ Optional EK not correctly fitted.	✓ Check small flange connection and if centering ring is correctly seated.	
	▶ Internal non-return valve switches.	✓ Normal when starting and stopping vacuum pump.	
	▶ Internal non-return valve opens and closes several times.	✓ Normal behavior under unfavorable pressure conditions at the inlet.	
	▶ Mechanical defect of vacuum pump, e.g., defective ball bearing.	✓ Send in vacuum pump.	Resp. specialist
	▶ Internal silencer clogged.	✓ Send in vacuum pump.	
Vapor condenser defective.	▶ Mechanically damaged.	✓ Replace vapor condenser.	Specialist

7 Cleaning and maintenance

	WARNING
	Danger due to electrical voltage. ⇒ Switch the product off before cleaning or maintenance work. ⇒ Unplug the power plug from the socket.
	Risk from contaminated parts. Pumping hazardous media can result in hazardous substances adhering to internal parts of the pump. ⇒ Wear your personal protective equipment, e.g., protective gloves, eye protection and, if necessary, respiratory protection. ⇒ Take safety precautions according to your instructions for handling hazardous substances.

NOTE

Damage possible if work is performed incorrectly.

- ⇒ Have maintenance work performed by a trained specialist or at least by a trained person.
- ⇒ Recommendation: Before carrying out maintenance work for the first time, please read through all the instructions to get an overview of the required service work.

7.1 Information on maintenance work

Recommended maintenance activities

Maintenance intervals

Maintenance intervals	If required
Clean surfaces	X
Clean / vacuum fan grilles	X
Clean / rinse vacuum pump	X
Replace filter at air inlet for regeneration mode	X

Recommended aids

→ Example
Recommended aids

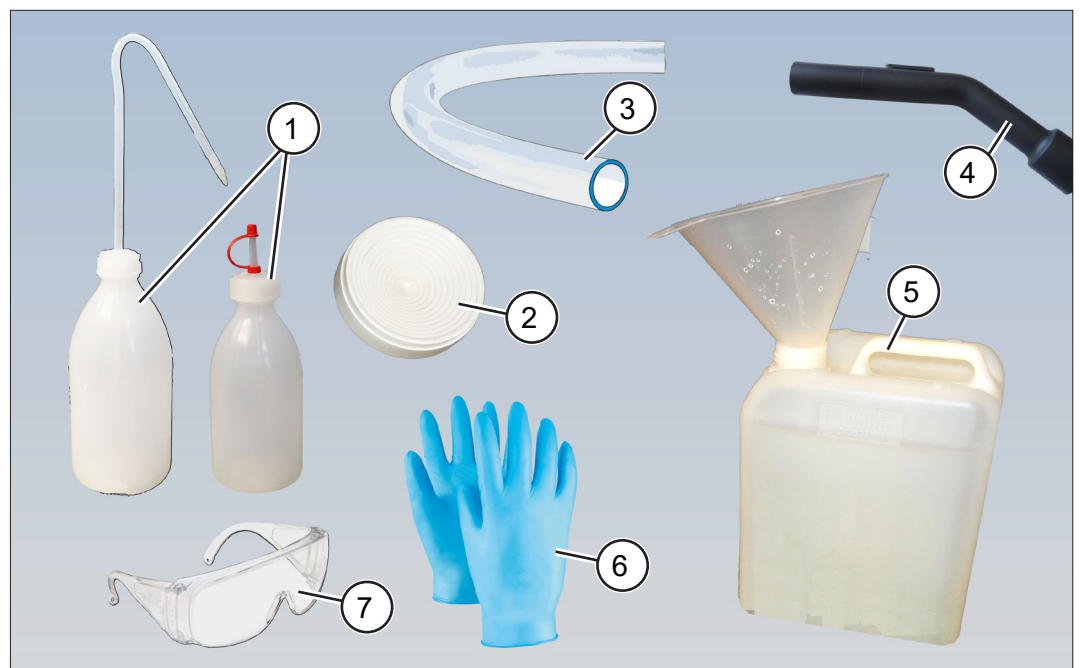

No.	Item
1	Spray bottle or drip bottle
2	Round bottom flask stand
3	Chemical resistant hose
4	Vacuum cleaner
5	Chemical resistant vessel, optionally with funnel
6	Protective gloves
7	Safety goggles

IMPORTANT!

⇒ Always wear your personal protective equipment when performing activities which may bring you into contact with hazardous substances.

7.2 Cleaning

This chapter does not contain descriptions for decontamination of the product. This chapter describes simple measures for cleaning and care.

⇒ Switch off vacuum pump before cleaning.

7.2.1 Clean the vacuum pump

Clean surfaces



⇒ Clean dirty surfaces with a clean, slightly damp cloth. We recommend using water or mild soapy water to moisten the cloth.

Clean the fan grilles

Clean the fan grilles

The fan grilles (2 pieces) are located on the right and left side of the pump.

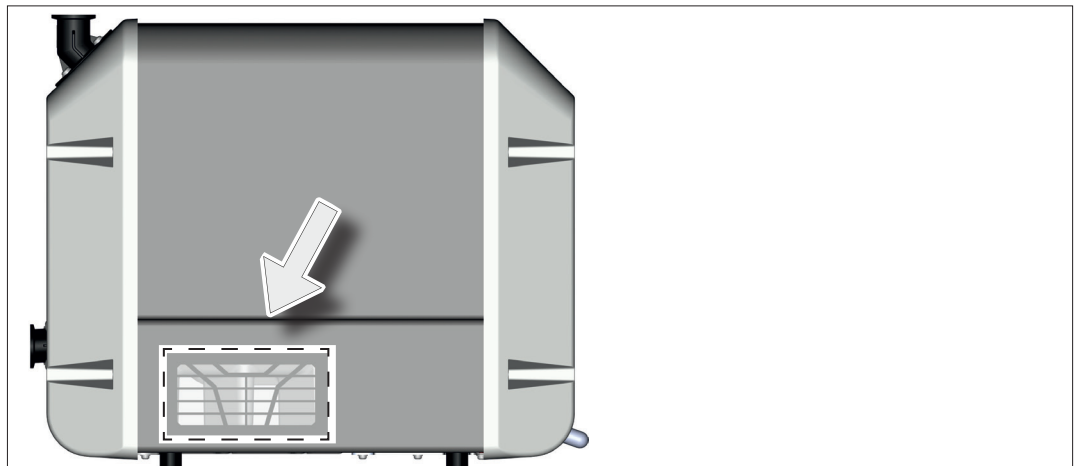

⇒ Clean dirty fan grilles, for example with a vacuum cleaner.

7.2.2 Empty glass flask (accessories)

Remove and empty glass flask at AK and / or EK

IMPORTANT!

⇒ Ventilate the glass flask at the inlet of the vacuum pump before opening the joint clamp.

Empty the glass flask

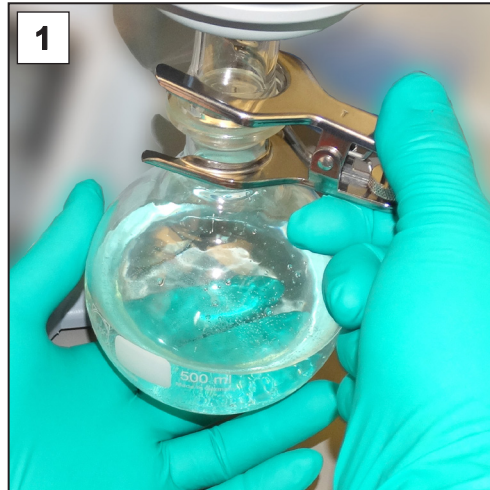

1. Open the joint clamp and remove the glass flask.

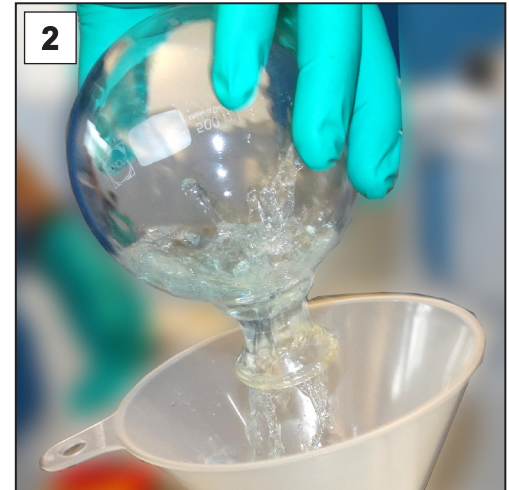

2. Empty the glass flask into a suitable container, e.g., chemical-resistant canister.

3. Then reattach the glass flask with the joint clamp.



Depending on the application, the collected liquid can either be reprocessed or must be disposed of properly.

7.3 Rinse vacuum pump

To rinse the vacuum pump, distilled water is pumped through it while it is running.

	DANGER
	<p>Risk of explosion due to use of solvents.</p> <p>The aspiration of solvents with air can lead to the formation of explosive mixtures. Due to the temperatures in the pump unit or in the event of an error, explosive mixtures may be ignited.</p> <ul style="list-style-type: none"> ⇒ Never use solvents to clean the pump unit, which can form inflammable and/or explosive mixtures with air. ⇒ Only use water to clean the pump unit.

	WARNING
	<p>Risk of scalding by hot water and steam at the outlet of the vacuum pump.</p> <p>Hot water and steam can cause scalding.</p> <ul style="list-style-type: none"> ⇒ Connect an outlet line to the outlet of the vacuum pump. ⇒ Guide the outlet line into a fixed, sufficiently large collecting vessel so that air and steam can escape. The outlet line and collecting vessel must be resistant to hot water and steam.



⇒ Wear your personal protective equipment.

Rinse the vacuum pump if one of the following points applies:

- there is pumped medium residue in the vacuum pump,
- the pumped media have formed deposits in the vacuum pump,
- the media for the next process may react with the media of the previous process or form explosive mixtures,
- there could still be residue or deposits of the pumped media in the vacuum pump and the vacuum pump should be shut down or stored.

Rinse vacuum pump

- Rinse vacuum pump
- ⇒ Use a commercially available drip bottle or spray bottle to rinse the vacuum pump.
 - ⇒ Only use distilled water to rinse the vacuum pump.
 - ⇒ Run the vacuum pump in regeneration mode.



Example of rinsing the vacuum pump



1. Connect an outlet line to the outlet and route it with a fall into a fixed collecting vessel.

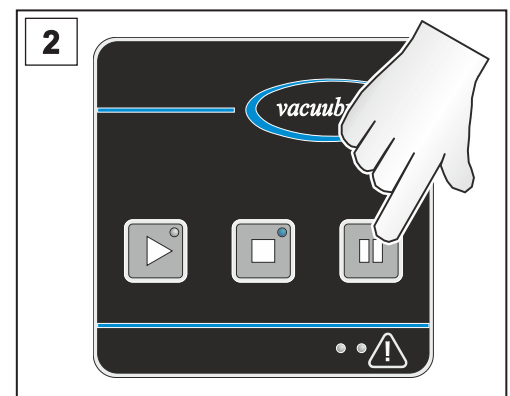

2. Start the vacuum pump in regeneration mode.

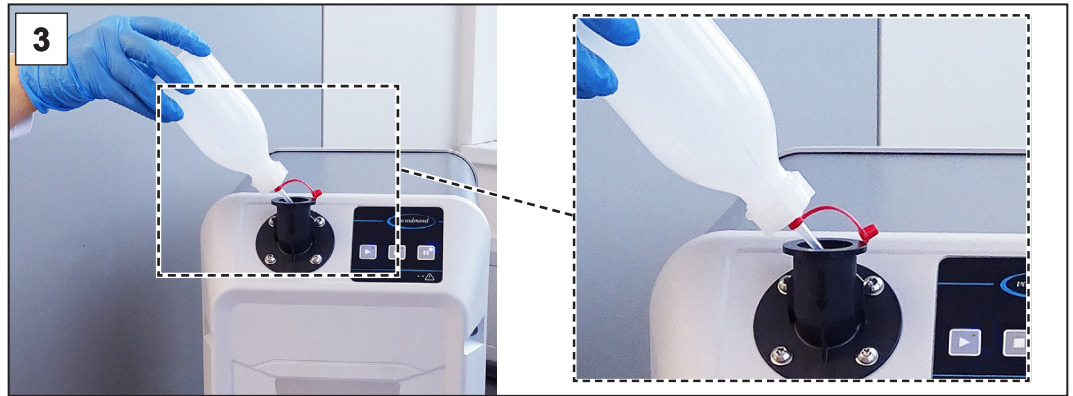

3. Gradually spray the distilled water directly into the pump inlet with the drip or spray bottle.
4. Rinse gradually with about 200 ml of distilled water.
5. If necessary, repeat the cleaning process until all residue is rinsed out of the vacuum pump.
6. After cleaning is complete, allow the vacuum pump to run with the inlet open for at least 60 minutes to convey the remaining water from the vacuum pump.

7.4 Air inlet filter

Replacement
of air inlet filter
(regeneration mode)

Position of the filter (air inlet for regeneration mode) on the vacuum pump:

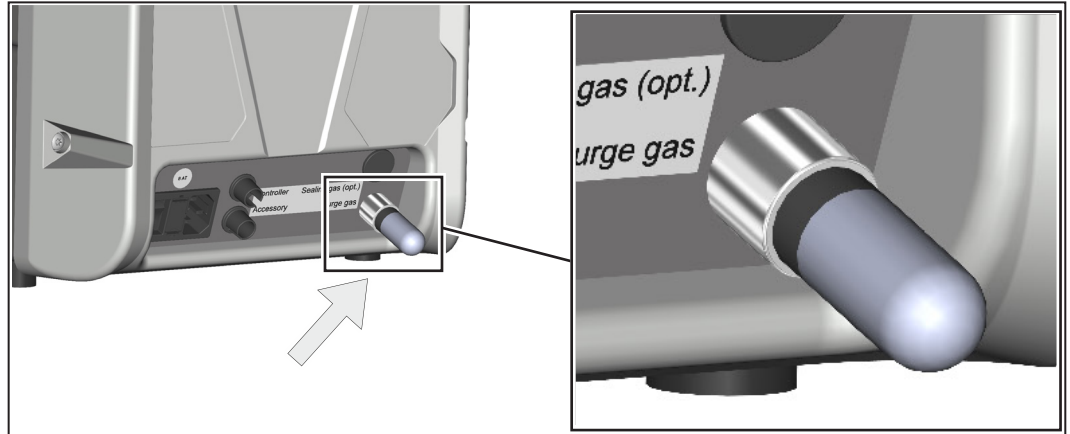

⇒ Replace a dirty or clogged air filter at the air inlet for regeneration mode.

The filter is available as a spare part, → see *chapter: 8.2 Ordering information on page 85*.

Replace filter at air inlet (regeneration mode)

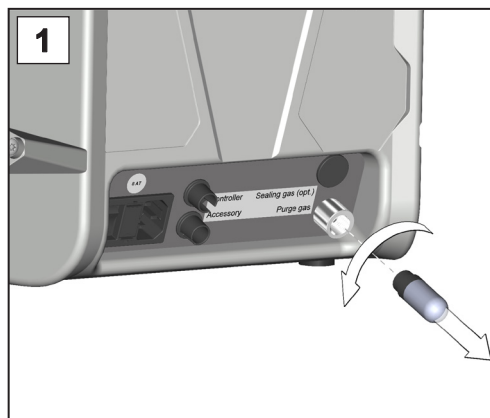

1. Unscrew the dirty filter at the purge gas inlet.

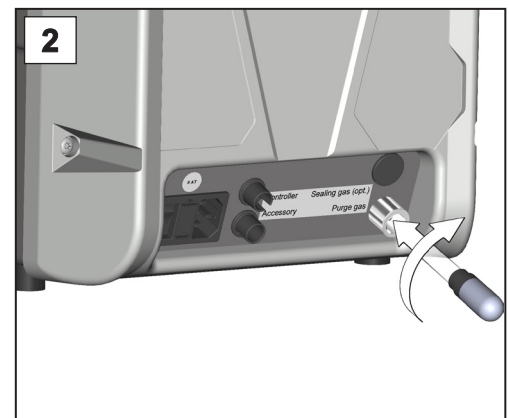

2. Screw in the new filter at the purge gas inlet.

7.5 Replace the device fuse

Replace the device fuse

You will find 2 device fuses at the power supply connection on the back of the vacuum pump, type: 250 V / 8 AT – 5x20

Replace the device fuse

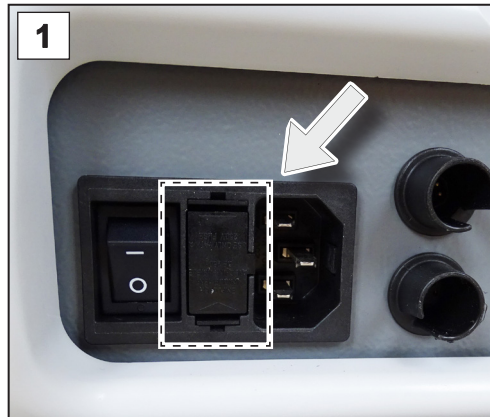

1. Unplug the power plug. The mains fuses are located in a fuse holder next to the on/off switch.

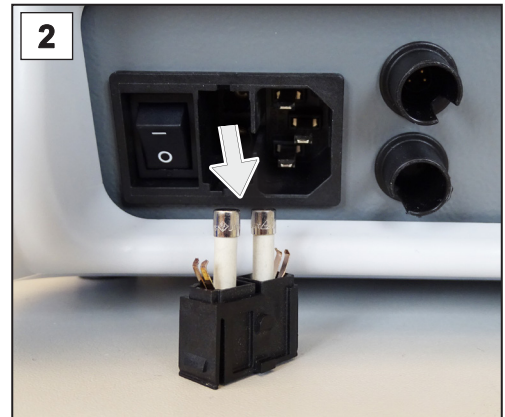

2. Keep the snap hooks pressed down. Carefully pull out the fuse holder.

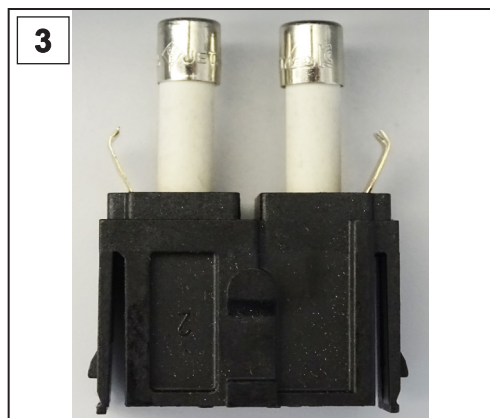

3. Replace the fuses.

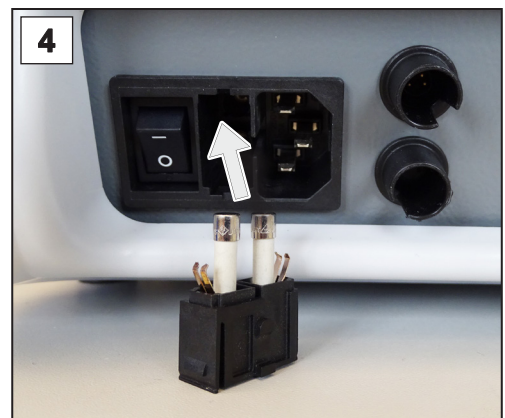

4. Slide the fuse holder onto the fuse base until it clicks into place.

8 Appendix

8.1 Technical information

8.1.1 Technical data

Vacuum pump

Vacuum pump
technical data

Ambient conditions		(US)
Ambient temperature, max.	10 – 40 °C	50 – 104 °F
Storage/transport temperature	-10 – 60 °C	14 – 140 °F
Max. altitude	2000 m above sea level	6562 ft above sea level
Relative humidity	30 – 85 %, non-condensing	
Pollution degree	2	
Impact energy	5 J	
Protection class (DIN 60529)	IP 20	
Protection class (UL 50E)	type 1	

Operating conditions		(US)
Maximum admissible media temperature (gas), non-explosive atmosphere:		
Short term (< 5 minutes)	80 °C	176 °F
Continuous operation	40 °C	104 °F
Max. surface temperature in the area in contact with the medium	200 °C	392 °F

Connections	
Vacuum connection IN (inlet)	Small flange KF DN 25
Outlet connection OUT	Small flange KF DN 25
Coolant EK (optional)	2 x hose nozzle DN 6/8
Outlet EK (optional)	Hose nozzle DN 19
Cold device plug	+ power supply CEE, CH, CN, UK, IN, US
Connection accessories (optional)	VACUU·BUS
Controller connection (optional)	VACUU·BUS / Modbus RTU

Technical data

Electrical data	
Nominal voltage	100 – 230 V ±10 %
Nominal frequency	50 / 60 Hz
Overvoltage category	II
Power, max.	700 W
Interface	VACUU·BUS / Modbus RTU
Power cord	2 m
Max. permissible load on VACUU·BUS connections	11 W
Device fuse 2x	250 V / 8 AT – 5x20

Vacuum data		(US)
Max. pumping speed	9 m ³ /h	5.3 cfm
Ultimate vacuum*, abs.	5*10 ⁻³ mbar	3.8*10 ⁻³ Torr
Max. inlet pressure, abs.	Atmospheric pressure (ATM)	
Max. outlet pressure, abs.	15 mbar above atmospheric pressure	11 Torr above atmospheric pressure

* Specification at 1013 mbar. Due to their functional principle, the ultimate vacuum of screw pumps of this design shows a dependency on the ambient pressure.

Mechanical data		(US)
Dimensions (L x W x H)	507 mm x 269 mm x 413 mm	20 in x 10.6 in x 16.3 in
Weight*	21.5 kg	47.4 lb

* without cable

Other information	
Emission sound pressure level* (uncertainty K _{pA} : 3 dB(A))	52 dB(A)
Volume of round bottom flask AK/EK (optional)	500 ml

* Measurement according to DIN EN ISO 2151:2009 and EN ISO 3744:1995 at ultimate vacuum with outlet line at outlet connection

Frequency converter

Frequency converter
technical data

Frequency converter		
Type	FC 700S 10	
Ambient conditions (US)		
Ambient temperature, max (end use)	10 – 40 °C	50 – 104 °F
Storage/transport temperature	-10 – 60 °C	14 – 140 °F
Installation height, maximum (end use)	2000 m above sea level	6562 ft above sea level
Relative humidity	30 – 85 %, non-condensing	
Pollution degree	2	
Protection class (DIN 60529)	IP 00	
EMC (DIN EN 61326) (end use)	CE Declaration	
Cooling (end use)	Actively cooled	
Electrical data		
Nominal voltage (IN)	100 – 230 V ±10 %	
Nominal frequency (IN)	50 / 60 Hz	
Power, max.	700 W	
Output voltage (OUT)	max. 400 VDC phase–phase	
Output frequency (OUT)	0 – 20 kHz	
Mechanical data (US)		
Housing	Open aluminum housing (drawer unit in end use)	
Dimensions (L x W x H)	220 mm x 253 mm x 119 mm	8.7 in x 10 in x 4.7 in
Weight including housing	1.96 kg	4.3 lb
Interfaces		
I/O interfaces	RS-485	
Internal power supply unit	24 VDC, 25 W (SELV)	
Function		
Software	Programming / parameterization	
Protective function	Overvoltage / undervoltage in the intermediate circuit; overcurrent; excessive temperature	

Overview of frequency converter board

Inputs and outputs on the frequency converter board

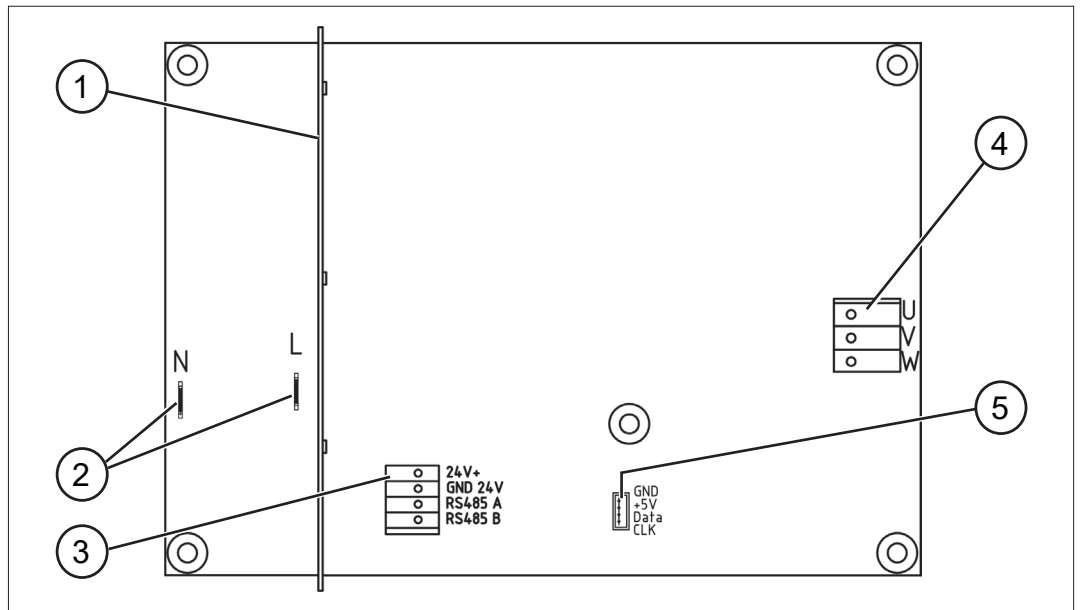

- 1 Shield circuit board
- 2 Power supply connection
- 3 Control cable connection
- 4 Motor connection
- 5 Encoder connection

8.1.2 Rating plates

Specifications on the rating plate



- ⇒ In the event of an error, make a note of the type and serial number on the rating plate.
- ⇒ When contacting our Service Department, please provide the type and serial number from the rating plate. This will allow us to provide you with specific support and advice for your device.

Vacuum pump rating plate

→ Example Vacuum pump rating plate

The diagram shows a rectangular rating plate for a vacuum pump. At the top center is the 'vacuubrand' logo in an oval. Below it, the text 'VACUUM PUMP' is centered. To the left, several labels with lines pointing to the plate indicate the following fields: 'Product series/type' points to 'VACUU-PURE 10C'; 'Serial number' points to 'S/N:'; 'Year of manufacture/month' points to '..... /'; 'Pumping speed' points to 'max. m³/h'; 'Ultimate vacuum' points to '..... mbar'; 'Power supply' points to '..... V, Hz, W'; and 'Manufacturer' points to the bottom section. On the right side of the plate, there are several certification logos: 'UK CA' (UK Conformity Assessed), a triangle logo with 'UL' and '1000', a crossed-out trash can, a '40' in a circle, and the 'CE' mark. The bottom section of the plate is blue and contains the text 'VACUUBRAND GMBH+CO KG', 'Alfred - Zippe - Str. 4', '97877 Wertheim', and 'Made in Germany'. Two yellow warning triangles are also present: one with an exclamation mark and one with a flame.

Frequency converter rating plate

→ Example Frequency converter rating plate

The diagram shows a rectangular rating plate for a frequency converter. At the top center is the text 'VACUUBRAND GMBH + CO KG'. Below it, the text 'Type' points to 'FC'. To the left, several labels with lines pointing to the plate indicate the following fields: 'Year of manufacture/month' points to '..... /'; 'Serial number' points to 'SN'; 'Power supply, Power' points to 'In: V, Hz, W'; 'Output voltage' points to 'Out: V, kHz'; and 'Manufacturer' points to the bottom section. On the right side of the plate, there is a triangle logo with 'UL' and '1000', and the text 'UL/C SA 61010-1'. The bottom section of the plate is blue and contains the 'vacuubrand' logo, 'Alfred - Zippe - Str. 4', '97877 Wertheim', and 'Made in Germany'.

8.1.3 Wetted materials

Wetted materials

Component	Wetted materials
Inlet flange, outlet flange, silencer, end cover of the pump unit	PPS
Spindles, stator, bearing plate	PEEK carbon fiber reinforced
Gaskets, flat gasket at the outlet	FKM
Non-return valve	PPS / PTFE / chemically resistant fluoroelastomer
Hose between non-return valve and pump unit	PTFE
Bonding/sealing of the silencer	Epoxy resin adhesive
Optional:	
Separator block AK	PP / PE
O-ring on separator	FKM / chemically resistant fluoroelastomer
Condenser EK	Borosilicate glass / PP / epoxy resin adhesive
Round bottom flask	Borosilicate glass

8.1.4 Use of chemicals

Use of chemicals

NOTE

Chemicals can damage the vacuum pump.

Chemicals can damage the wetted parts of the vacuum pump.

- ⇒ Check the compatibility of the pumped substances with the wetted materials of the vacuum pump, → see *chapter: 8.1.3 Wetted materials on page 83*.
- ⇒ Do not use the vacuum pump in connection with substances, which can dissolve PEEK like for example sulfuric acid or halogenated phenols.
- ⇒ Protect the vacuum pump reliably against the penetration by other harmful substances, e.g., by using a cold trap.

The wetted parts of the pump spindles, the stator and the bearing plate of the vacuum pump are made of polyetheretherketone (PEEK). PEEK is a high performance plastic with exceptionally good chemical resistance.

Few chemicals are known to have attacked or even dissolved PEEK. These include sulfuric acid and various halogenated phenols. These substances must not get into the vacuum pump. The vacuum pump must not be used in connection with these substances.

Depending on the operating conditions such as duration, temperature, moisture content and concentration of the substances, some strong acids, such as nitric acid and hydrogen fluoride, as well as halogens can attack the PEEK surfaces. When used with these substances, the vacuum pump must be reliably protected against penetration by these substances, e.g., by using cold traps.

8.2 Ordering information

Vacuum pump
ordering information

Vacuum pump		Order no.
VACUU·PURE 10C	CEE	20751000
	CH	20751001
	UK	20751002
	US	20751003
	CN	20751006
	IN	20751007

Ordering information
for accessories

Accessories	Order no.
Separator AK	20751802
Vapor condenser EK	20751801
VACUU·PURE shuttle	20751800
Adapter KF DN 25 / SW DN 15, PP	20662808
Adapter KF DN 25 / SW DN 10, PP	20662807
Elbow with small flange KF DN 25 and hose nozzle for tubing d _i 19 mm, PP	20751803
PTFE hose KF DN 25 (l = 1000 mm)	20686033
Centering and sealing ring KF DN 25 C Al/FEP	20635722
Clamping ring KF DN 25, aluminum	20660001
Hose for outlet, d _i 19 mm, PVC (sold by meter)	20686056
VACUU·SELECT package for fine vacuum control with VACUU·SELECT controller, VACUU·VIEW extended, In-line valve VV-B 15C, connecting parts KF DN 25, stainless steel 100 – 230 V / 50 – 60 Hz	20700110
Vacuum gauge VACUU·VIEW extended, 1100 – 0.001 mbar, VACUU·BUS	20683210
In-line solenoid valve VV-B 15C, VACUU·BUS	20674215
Coolant valve VKW-B, VACUU·BUS	20674220
Level sensor, VACUU·BUS	20699908
Digital I/O module	20636228
VACUU·BUS Y adapter	20636656
Extension cable VACUU·BUS, 0.5 m	20612875
Extension cable VACUU·BUS, 2 m	20612552
Extension cable VACUU·BUS, 5 m	20612931
Extension cable VACUU·BUS, 10 m	22618493
VACUU·BUS Communication Kit, USB to VACUU·BUS converter	20683230

Ordering information
Spare parts

Spare parts		Order no.
Filter air inlet (regeneration mode)		20638411
O-ring inlet flange		20638419
Flat gasket at outlet (FKM) (2x)		20638420
Hose nozzle DN 6, bent (EK, optional)		20639948
Joint clamp VA KS35/25		20637627
Glass flask/round bottom flask 500 ml		20638497
Power cord	CEE	20612058
	CH	20676021
	CN	20635997
	IN	20635365
	UK	20676020
	US	20612065

Sources of supply

International
sales offices and
distribution

Purchase original accessories and original spare parts from a subsidiary of **VACUUBRAND GMBH + CO KG** or your local distributor.



Information about our complete product range is available in the current [product catalog](#).

⇒ Your local distributor or **VACUUBRAND GMBH + CO KG** [sales office](#) is available to assist you with orders, questions on vacuum control and optimal accessories.

8.3 Service

Service offer and
service range

Take advantage of the comprehensive range of services available from **VACUUBRAND GMBH + CO KG**.

Services in detail

- Product consultation and practical solutions
 - Fast delivery of spare parts and accessories
 - Professional maintenance
 - Immediate repairs processing
 - On-site service (on request)
 - With Health and Safety Clearance form: return, disposal
- ⇒ Visit our website for further information: www.vacuubrand.com.

Service handling

Meet
terms of service

⇒ Follow these headings: VACUUBRAND > Support > [Service](#)



Reduce downtime, speed up processing. Please have the required data and documents at hand when contacting our Service Department.

- ▶ Your order can be quickly and easily processed.
- ▶ Hazards can be prevented.
- ▶ A brief description and/or photos will help locate the source of the error.

8.4 Index

Index	A	L
	Abbreviations 10	Labels and signs 22
	Accessories 85	Level sensor 55
	Action steps 9	Limitation of use 34, 42
	Additional symbols 8	M
	Adjust liquid level sensor 56	Maintain minimum distance 22
	Advanced operation 49	Mandatory sign 8
	Air inlet filter 76	Manual structure 6
	Autostart 21, 48	Minimum distances 34
	Avoid overpressure 19	misuse 14
	B	Modbus RTU protocol 30
	Blockage protection 23	N
	C	Non-return valve 11
	Chemical resistance, high 24	O
	Cleaning and maintenance 69	Operating elements 45
	Clean the fan grilles 71	Operating steps as graphics 9
	Condensate 20	Operator obligations 15
	Control panel 44	Ordering information 85
	Coolant connection 42	Outlet connection 39
	Coolant valve 55	Outlet line 39
	Copyright © 5	Overheating 22
	CU Certificate 92	Overheating protection 23
	D	P
	Display conventions 7	Perform BUS scan 54
	Display elements 45	Personnel obligations 15
	Display of operating steps 9	Personnel qualification 16
	Disposal 23	Power cord 43
	Distributors 86	Prevent condensate return 19, 20
	E	Product description 24
	EC Declaration of Conformity 90	Product-specific terms 10
	Electrical connection 43	Prohibition sign 8
	Eliminate sources of danger 19	Protective clothing 17
	Error – Cause – Remedy 62	Q
	Error indication 60	Qualification description 16
	Error messages 59	Quality standard 17
	Examples of use 31	R
	Explanation of safety symbols 8	Regeneration mode 11, 20, 25, 47
	F	Remote mode 52
	Factory setting 51	Replace the device fuse 77
	Frequency converter rating plate 82	Residual energy 21
	G	Responsibility matrix 16
	Goods receipt 32	Restart, automatic 21, 48
	I	Rinse vacuum pump 73
	Icons 8	Rotate the inlet flange 37
	Improper use 14	S
	In-line solenoid valve 55	Safety information 13
	Installation and connection 32	Safety precautions 17
	Instruction 9	Sealing gas 11, 19
	Instruction modules 6	Separator (AK) 27
	Intended use 13	Service handling 87
		Service range 87

Index	Shutdown	57
	Sources of supply	86
	Spare parts	85
	Start	46
	Switch on	44
	Symbols	8
T		
	Target groups	16
	Technical data for vacuum pump	78
	Technical information	78
	Technical support	61
	Term definitions	10
U		
	UKCA Declaration of Conformity	91
	Unpacking	32
	User information	5
V		
	VACUU·BUS	11
	VACUU·BUS accessories	29, 53
	VACUU·BUS address	11
	VACUU·BUS client	11
	VACUU·BUS connector	11
	Vacuum connection (IN)	35
	Vacuum pump rating plate	82
	VACUU·PURE shuttle	27
	Vapor condenser (EK)	27, 40
W		
	Warm up times	46
	Warm-up times	46
	Warnings	59
	Warning symbol	8
	Wetted materials	83

8.5 EC Declaration of conformity

EC Declaration of
Conformity

EG-Konformitätserklärung für Maschinen EC Declaration of Conformity of the Machinery Déclaration CE de conformité des machines



Hersteller / Manufacturer / Fabricant:

VACUUBRAND GMBH + CO KG · Alfred-Zippe-Str. 4 · 97877 Wertheim · Germany

Hiermit erklärt der Hersteller, dass das Gerät konform ist mit den Bestimmungen der Richtlinien:

Hereby the manufacturer declares that the device is in conformity with the directives:

Par la présente, le fabricant déclare, que le dispositif est conforme aux directives:

- 2006/42/EG
- 2014/30/EU
- 2011/65/EU, 2015/863

Vakuumpumpe / Vacuum pump / Pompe à vide:

Typ / Type / Type: **VACUU-PURE 10C**

Artikelnummer / Order number / Numéro d'article: **20751000, 20751001, 20751002, 20751003, 20751006, 20751007**

Seriennummer / Serial number / Numéro de série: Siehe Typenschild / See rating plate / Voir plaque signalétique

Angewandte harmonisierte Normen / Harmonized standards applied / Normes harmonisées utilisées:

EN ISO 12100:2010 (ISO 12100:2010), EN 1012-2:1996 + A1:2009, EN 61010-1:2010 + A1:2019 + A1:2019/AC:2019
(IEC 61010-1:2010 + COR:2011 + A1:2016, modifiziert / modified / modifié + A1:2016/COR1:2019)

EN IEC 61326-1:2021 (IEC 61326-1:2020)

EN IEC 63000:2018 (IEC 63000:2016)

Bevollmächtigter für die Zusammenstellung der technischen Unterlagen / Person authorised to compile the
technical file / Personne autorisée à constituer le dossier technique:

Dr. Constantin Schöler · VACUUBRAND GMBH + CO KG · Germany

Ort, Datum / place, date / lieu, date: Wertheim, 02.05.2024

(Dr. Constantin Schöler)

Geschäftsführer / Managing Director / Gérant

ppa.

(Jens Kaibel)

*Technischer Leiter / Technical Director /
Directeur technique*

VACUUBRAND GMBH + CO KG

Alfred-Zippe-Str. 4
97877 Wertheim

Tel.: +49 9342 808-0

Fax: +49 9342 808-5555

E-Mail: info@vacuubrand.com

Web: www.vacuubrand.com

VACUUBRAND®

8.6 UKCA Declaration of conformity

UKCA Declaration
of Conformity

Declaration of Conformity



Manufacturer:

VACUUBRAND GMBH + CO KG · Alfred-Zippe-Str. 4 · 97877 Wertheim · Germany

Hereby the manufacturer declares that the device is in conformity with the directives:

- Supply of Machinery (Safety) Regulations 2008
(S.I. 2008 No. 1597, as amended by S.I. 2019 No. 696)
- Electromagnetic Compatibility Regulations 2016
(S.I. 2016 No. 1091, as amended by S.I. 2019 No. 696)
- The Restriction of the Use of Certain Hazardous Substances in Electrical and Electronic Equipment Regulations 2012 (S.I. 2012 No. 3032)

Vacuum pump:

Type: **VACUU·PURE 10C**

Order number: **20751000, 20751001, 20751002, 20751003, 20751006, 20751007**

Serial number: See rating plate

Designated standards applied:

EN ISO 12100:2010, EN 1012-2:1996+A1:2009, EN 61010-1:2010+A1:2019, EN 61010-1:2010/A1:2019/AC:2019-04
EN 61326-1:2013
EN IEC 63000:2018

Person authorised to compile the technical file:

Dr. Constantin Schöler · VACUUBRAND GMBH + CO KG · Germany

Place, date: Wertheim, 02.05.2024

(Dr. Constantin Schöler)

Managing Director

ppa.

(Jens Kaibel)

Technical Director

VACUUBRAND GMBH + CO KG

Alfred-Zippe-Str. 4
97877 Wertheim

Tel.: +49 9342 808-0

Fax: +49 9342 808-5555



E-Mail: info@vacuubrand.com

Web: www.vacuubrand.com

VACUUBRAND®

8.7 CU Certificate

CU Certificate

<h1>Certificate</h1>		 TÜVRheinland®
Certificate no.	CU 72213105 01	
License Holder: VACUUBRAND GMBH + CO KG Alfred-Zippe-Str. 4 97877 Wertheim Deutschland	Manufacturing Plant: VACUUBRAND GMBH + CO KG Alfred-Zippe-Str. 4 97877 Wertheim Deutschland	
Test report no.: USA- 32084593 001	Client Reference: Dr. Wollschläger	
Tested to:	UL 61010-1:2012 R7.19 CAN/CSA-C22.2 NO. 61010-1-12 + GI1 + GI2 (R2017) + A1	
Certified Product: Vacuum Pump	License Fee - Units	
Model Designation: VACUU·PURE 10; VACUU·PURE 10C	7	
Rated Voltage: AC 100-230 V; 50/60 Hz		
Rated Power: 700 A		
Protection Class: I		
Remark: VACUU·PURE 10 is a non-chemical resistant version VACUU·PURE 10C is a chemical resistant version	7	
Appendix: 1, 1 - 6		
Licensed Test mark:	Date of Issue (day/mo/yr)	
 C U S	25/08/2021	
<small>TUV Rheinland of North America, Inc., 12 Commerce Road, Newtown, CT 06470, Tel (203) 426-0888 Fax (203) 426-4009</small>		

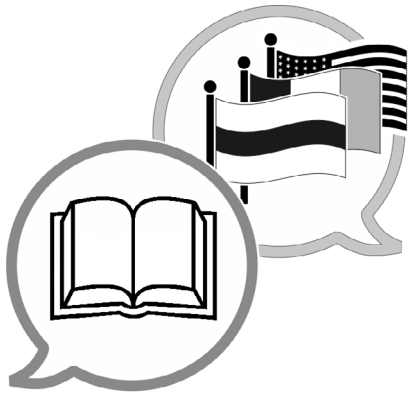

www.vacuubrand.com/manuals

Manufacturer:

VACUUBRAND GMBH + CO KG
Alfred-Zippe-Str. 4
97877 Wertheim
GERMANY

Phone:

Head office +49 9342 808-0
Sales +49 9342 808-5550
Service +49 9342 808-5660

Fax: +49 9342 808-5555

Email: info@vacuubrand.com

Web: www.vacuubrand.com