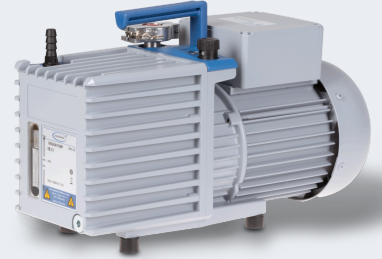

旋片泵

RZ 2.5

[网站链接](#)

产品说明

RE 2.5单级旋片泵和RZ 2.5双级旋片泵性能优异，结构紧凑，重量轻。对于大量需求较好极限真空和中等抽速的实验室及工艺应用中，它们是理想的解决方案。该真空系统的结构紧凑，易于使用，结构合理。RZ 2.5也可选配的油雾过滤器FO和VS 16阀套件。

性能特点

- 在接近极限真空时仍能有很高的抽气速度
- 开启气镇仍达到很好的极限真空
- 关机时可保持真空密封；无需外置防倒吸阀
- 储油体积大：换油间隔时间长
- 采用“镜筒”式设计，易于维护

订购信息

产品名称	额定电源电压 工作频率	电源插头类型	订货号
RZ 2.5	230 V 50-60 Hz	UK, IN	20798122

货品配置

泵油已安装，泵体安装完毕，连接即可使用，附带说明书

配件

- 带小法兰的金属真空管 KF DN 16 (20673336)
- 进气口分离瓶 AK for RE/RZ 5/6/2.5 (20698006)
- 出气口油雾过滤器 FO R 2/2.5/5/6 (20698003)
- 高真空控制套装 VACUU-SELECT + VACUU-VIEW extended, KF DN 16 (20700100)
- 高真空控制套装 VACUU-SELECT + VSP 3000, KF DN 16 (20700101)
- 橡胶真空管 DN 8 mm (20686001)
- 带软管喷嘴接头的小法兰 KF DN 16 / DN 10 mm (20662806)

技术指标

50 Hz 最大抽速 (mbar)	2.3 m ³ /h
60 Hz 最大抽速 (cfm)	1.65 cfm
极限真空	2 x 10 ⁻³ mbar / 1.5 x 10 ⁻³ torr
极限真空, 使用气镇	1 x 10 ⁻² mbar / 0.75 x 10 ⁻² torr
不开气镇的极限分压, 单位	4 x 10 ⁻⁴ mbar / 3 x 10 ⁻⁴ torr
泵级数	2
的允许环境温度范围 (运行)	12 - 40 °C
的允许环境温度范围 (存放)	-10 - 60 °C
最大出气口压力 (绝对压力)	1.1 bar
注油量 min./max.	0.36 / 0.84 l
进气口连接	KF DN 16 小法拉 / DN 10 mm 软管喷嘴接头
出气口连接	软管喷嘴接头 DN 8-10 mm
额定电机功率	0.1 kW
额定转速 50/60 Hz	1500/1800 min ⁻¹
防护等级	IP 40
尺寸 (长x宽x高)	390 mm x 156 mm x 240 mm
重量	14.2 kg
噪音水平 50 Hz/1500 Upm/62% (VARIO)/1500 Upm (VARIO-SP)/12500 Upm (VACUU·PURE®)	48 dBA
NRTL 标准	否

50 Hz下的抽速曲线

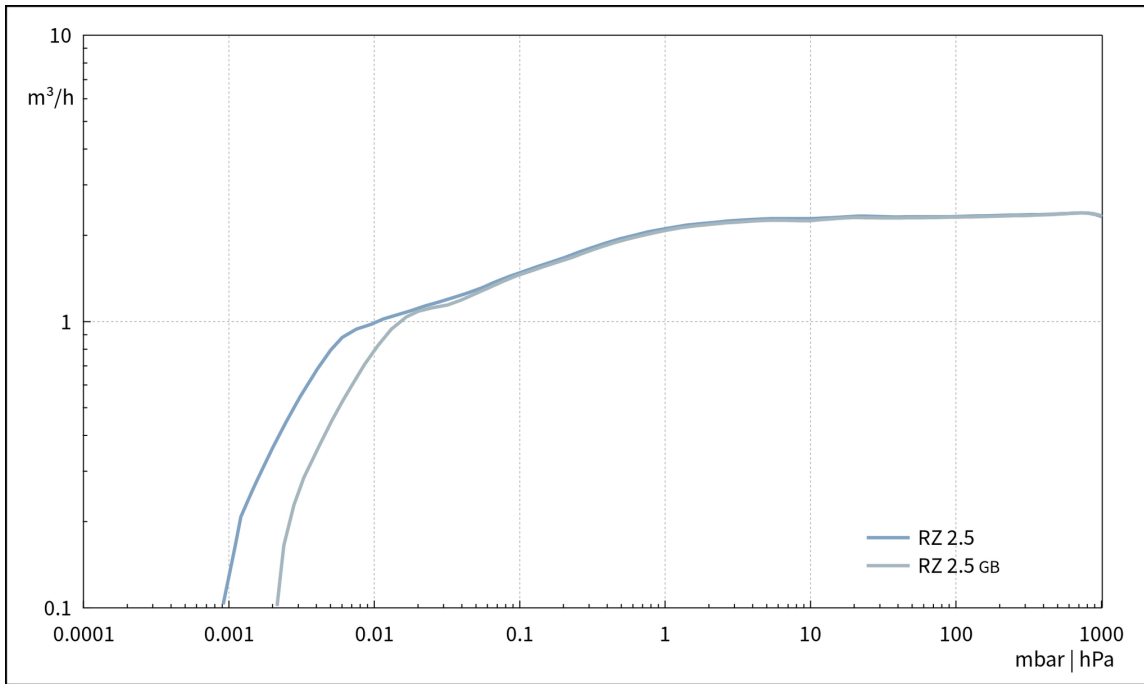

50 Hz下的抽气曲线 (10升容积)

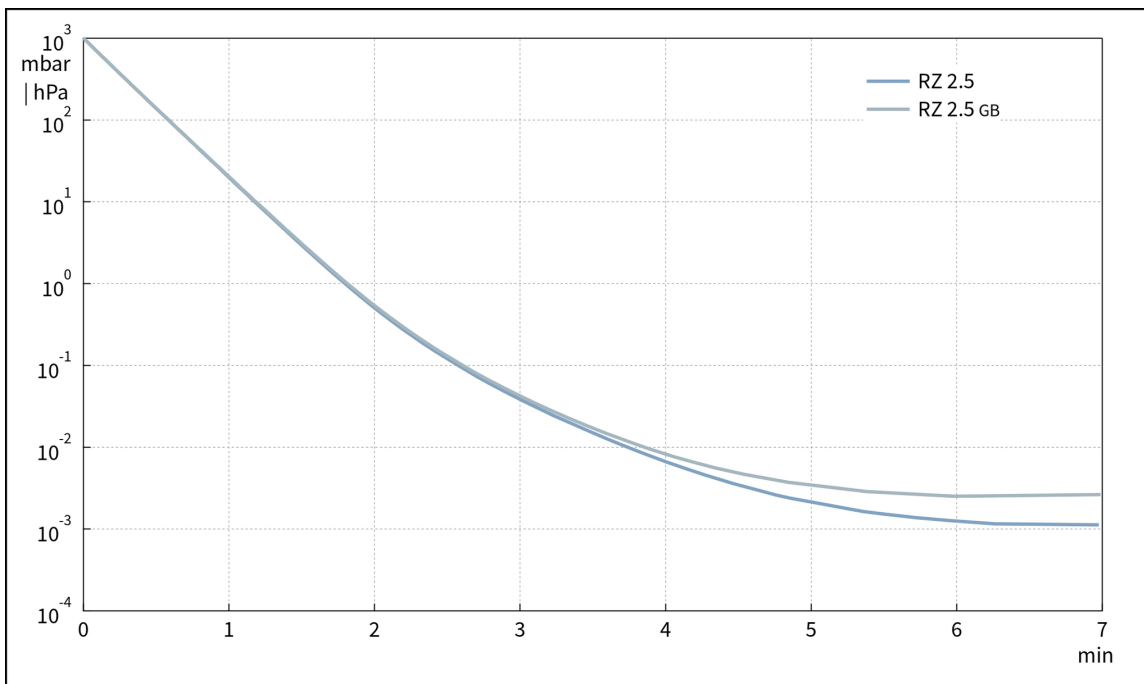

60 Hz下的抽速曲线

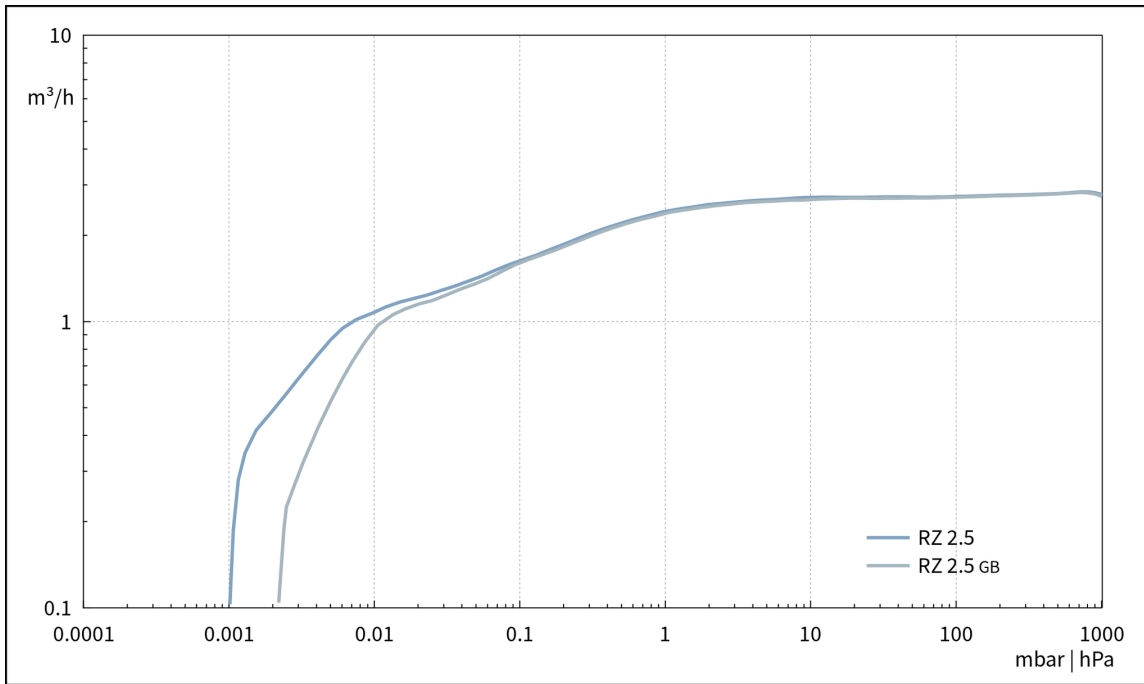

60 Hz下的抽气曲线 (10升容积)

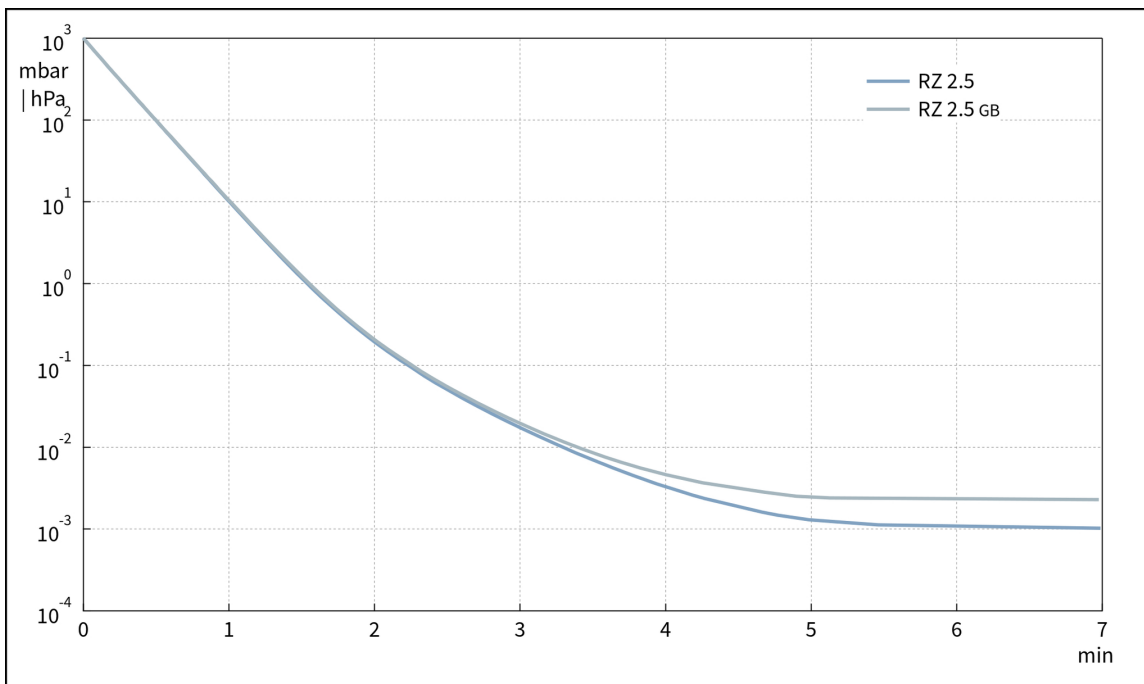

尺寸规格表

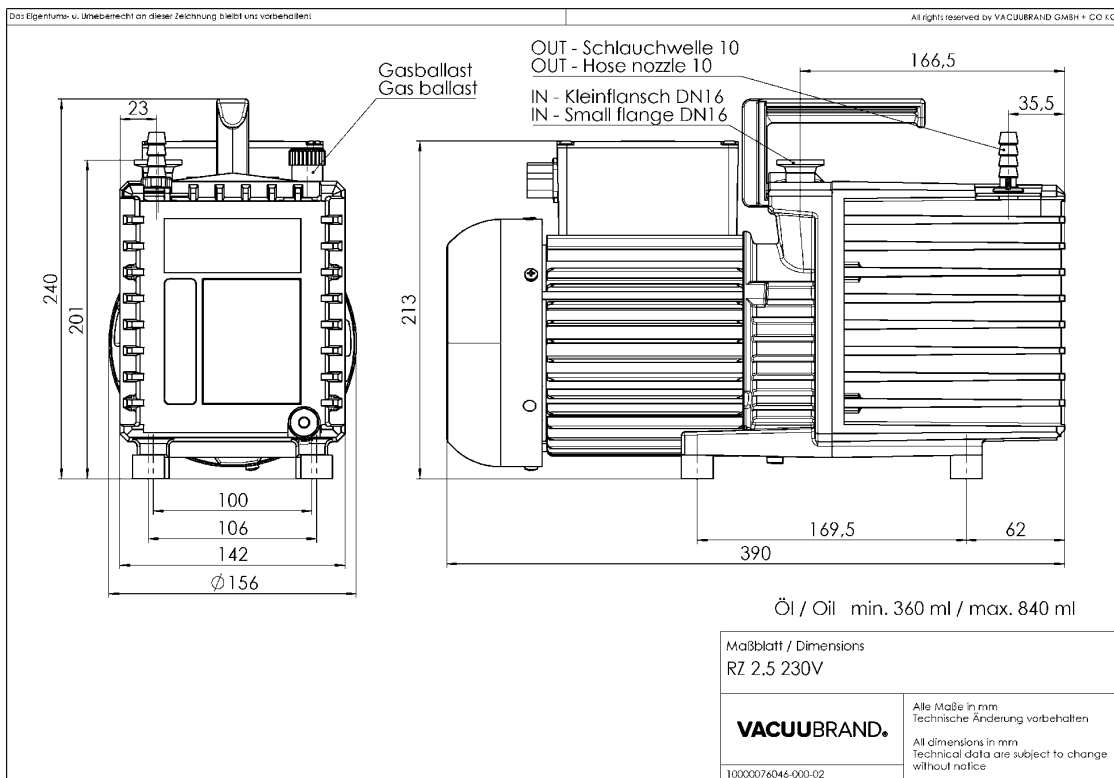
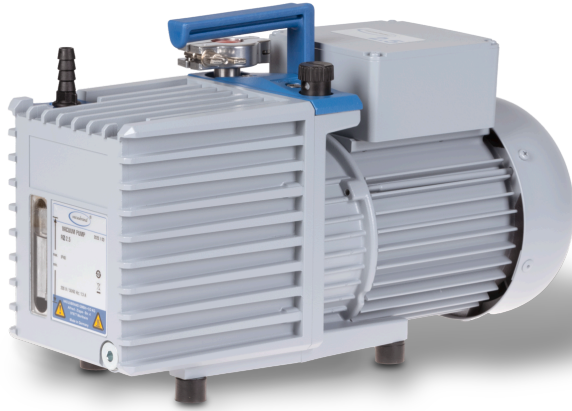

VACUUBRAND GMBH + CO KG
P.O. Box 1664
97877 Wertheim
T +49 9342 808 5550
F +49 9342 808 5555

info@vacuubrand.com
www.vacuubrand.com

VACUUBRAND®

VACUUBRAND is part of the Brand group, a manufacturer of high-quality and innovative laboratory equipment and vacuum technology with a global team of approx. 1,000 employees.

With highly motivated and qualified employees, we manufacture the world's most comprehensive product family for vacuum generation, measurement and control for the rough and fine vacuum range in the laboratory.

All with one goal:

Enabling our customers to run reliable, safe and efficient processes. This is why we commit ourselves to continuous innovation, first-class performance, and outstanding quality.

Engineering excellence is central to our ability to deliver products and solutions renowned for their quality, durability, and reliability. Innovative technology, high quality materials and extensive testing deliver unmatched performance - engineered and manufactured in Germany.

Together with you, our experts will find the best solution for your application and provide you with first-class service along the way.

BRAND (Shanghai) Trading Co., Ltd.
Shanghai, China

T +86 21 6422 2318
info@brand.com.cn
china.brand.com.cn

BRAND Scientific Equipment Pvt. Ltd.
Mumbai, India

T +91 22 42957790
customersupport@brand.co.in
www.brand.co.in

BRANDTECH® Scientific, Inc.
Essex, CT. United States of America

T +1 860 767 2562
info@brandtech.com
www.brandtech.com